

M100/72 - Mining heavy duty air-hydraulic jack

Jack designed for use with mining equipment.

M100/72 main features:







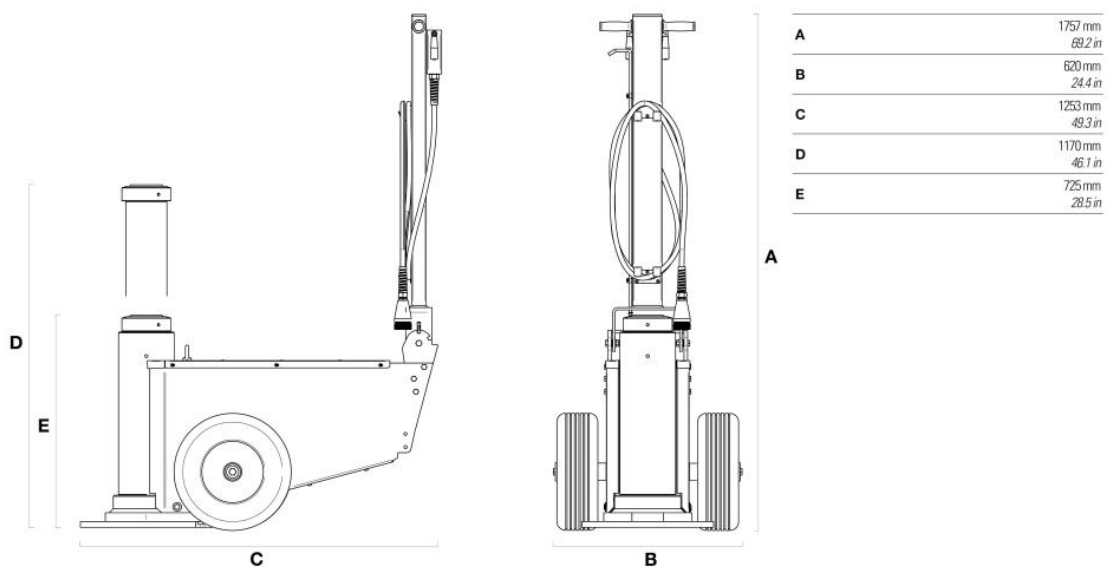

- ▶ Light, compact, easy to handle
- ▶ Folding handle
- ▶ Equipped with remote control
- ▶ Pneumatic tyres for any surface



Capacity:	100 t 110.2 ton
Net weight:	324 Kg 714 lb
Working air pressure:	10-12 bar 145-174 psi
Air consumption:	600 nl/min
Stroke:	445 mm 17.5 in
Min. height:	725 mm 28.5 in
Number of pistons:	1
Pistons stroke:	445 mm 17.5 in



Compatible accessories:

-  Safety locking device kit A00788
-  Extension A02421
-  Extension A02422
-  Extension A02423
-  Plate A04495
-  Extension holder A06053
-  Remote control A06051
-  Remote control A06052