











SOLLEVATORI IDRAULICI A CARRELLO HYDRAULIC TROLLEY JACKS

Mod.

	YAK 13/OL	YAK 20	YAK 20/Q	YAK 20/OL
	•			
	•	•	•	•
	•	•	•	•
	•	•	•	•
	•	•	•	•
		•	•	•
		•	•	•
		•	•	•

Sollevatori idraulici manuali carrellati.

L'azionamento manuale della pompa avviene attraverso il movimento del manico. Sui modelli "Q" è presente inoltre l'avvicinamento rapido a pedale. Leggeri e maneggevoli, ideali per gommisti, officine e carrozzerie.

Manual hydraulic trolley jacks.

The pump is manually operated by handle movement. The pedal control on "Q" models is used for a quick approach. Lightweight and easy to handle, ideal for tyre repairers, workshops and bodywork shops.





YAK 13/QL

YAK 20

YAK 20/Q

YAK 20/QL



YAK 13/QL



YAK 20



YAK 20/Q



YAK 20/QL

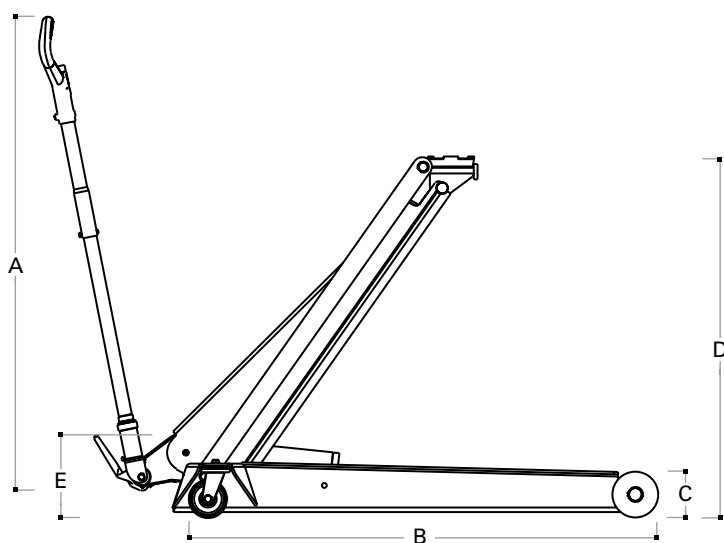

	YAK 13/QL	YAK 20	YAK 20/Q	YAK 20/QL
Portata Capacity	1,3 t <i>1.4 ton</i>	2 t <i>2.2 ton</i>	2 t <i>2.2 ton</i>	2 t <i>2.2 ton</i>
Peso netto Net weight	38 kg <i>84 lb</i>	31 kg <i>68 lb</i>	31 kg <i>68 lb</i>	49 kg <i>108 lb</i>
A	950 mm <i>37.40 in</i>	950 mm <i>37.40 in</i>	950 mm <i>37.40 in</i>	950 mm <i>37.40 in</i>
B	940 mm <i>37.00 in</i>	660 mm <i>25.98 in</i>	660 mm <i>25.98 in</i>	950 mm <i>37.40 in</i>
C	80 mm <i>3.15 in</i>	80 mm <i>3.15 in</i>	80 mm <i>3.15 in</i>	80 mm <i>3.15 in</i>
D	735 mm <i>28.94 in</i>	495 mm <i>16.49 in</i>	495 mm <i>16.49 in</i>	795 mm <i>31.3 in</i>
E	160 mm <i>6.30 in</i>	160 mm <i>6.30 in</i>	160 mm <i>6.30 in</i>	220 mm <i>8.66 in</i>