











# SOLLEVATORE OLEOPNEUMATICO AIR HYDRAULIC JACK

	Mod.	
	YAK 214/N	YAK 214/P
	•	•
	•	•
	•	•
	•	•
	•	•
	•	•
	•	•
	•	•
	•	•
	•	•

Estremamente leggeri, compatti e performanti. Costituiti con i migliori materiali in commercio, i modelli YAK214/N e YAK214/P rappresentano l'evoluzione più tecnologica dei nostri prodotti. I materiali di primissima qualità utilizzati mantengono il modello YAK214/P entro i 15Kg / 33lb rendendolo di fatto il più leggero e compatto mai costruito.

*Extremely light, compact and efficient. Made up with the best materials on the market, YAK214/N and YAK214/P represent the technological leading edge of our product range. The high quality materials used keep YAK214/P within 15Kg/33lb weight, making it the lightest and most compact jack we ever built.*

#### ACCESSORI DI SERIE - STANDARD ACCESSORIES





# YAK 214/N

# YAK 214/P



A04564

CASSA TROLLEY INCLUSA - TROLLEY BOX INCLUDED



YAK 214/N

YAK 214/P

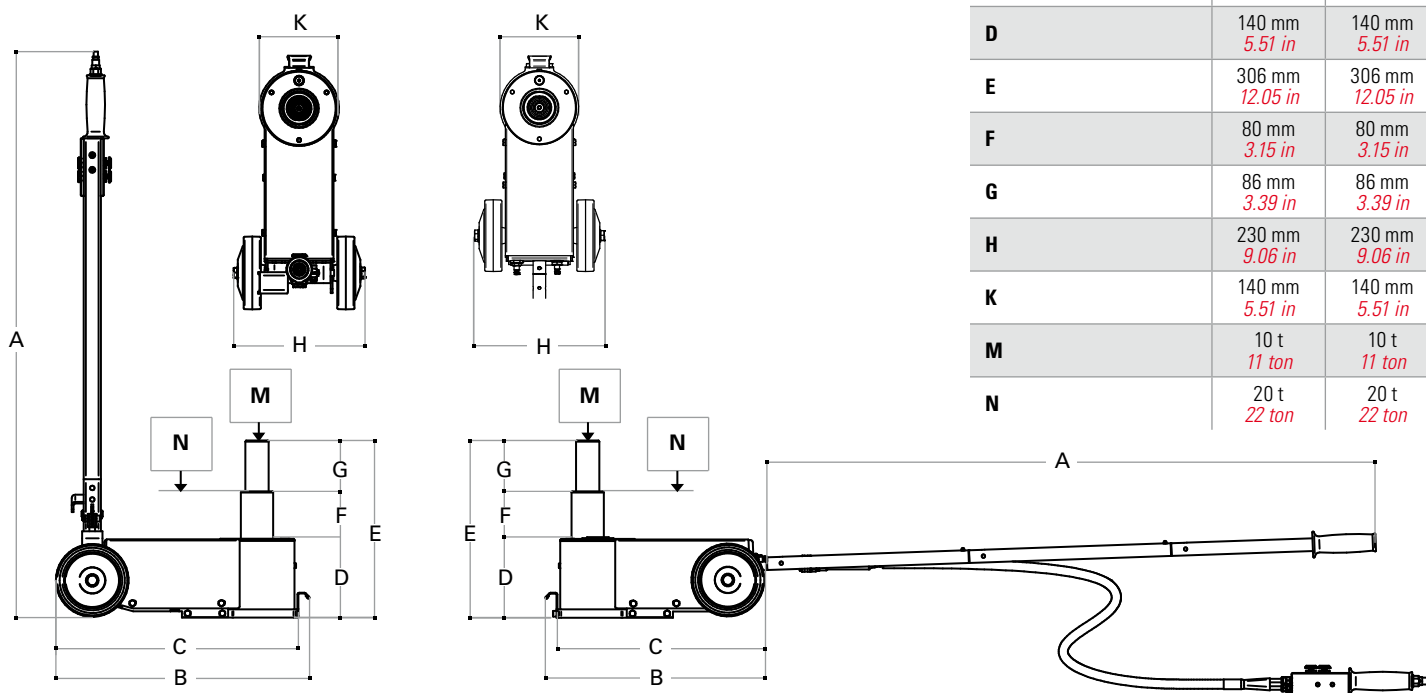

	YAK 214/N	YAK 214/P
Portata Capacity	20-10 t 22-11 ton	20-10 t 22-11 ton
Peso netto Net weight	17.5 kg 38.5 lb	15 kg 33 lb
Pressione di alimentazione Working air pressure	8-10 bar 116-145 psi	8-10 bar 116-145 psi
Consumo d'aria Air waste	350 nl/min	350 nl/min
A	980 mm 38.58 in	354-1052 mm 13.94-41.42 in
B	440 mm 17.32 in	380 mm 14.96 in
C	420 mm 16.54 in	360 mm 14.17 in
D	140 mm 5.51 in	140 mm 5.51 in
E	306 mm 12.05 in	306 mm 12.05 in
F	80 mm 3.15 in	80 mm 3.15 in
G	86 mm 3.39 in	86 mm 3.39 in
H	230 mm 9.06 in	230 mm 9.06 in
K	140 mm 5.51 in	140 mm 5.51 in
M	10 t 11 ton	10 t 11 ton
N	20 t 22 ton	20 t 22 ton