









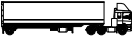

SOLLEVATORE OLEOPNEUMATICO

AIR HYDRAULIC JACK



Mod.

	YAK 215/L	YAK 315/L
	•	•
	•	•
	•	•
	•	•
	•	•
	•	•
	•	•
	•	•
	•	•
	•	•

Sollevatore Oleopneumatico per mezzi pesanti, pratico e maneggevole. Rientro automatico dei pistoni; le due valvole di discesa garantiscono una tenuta perfetta in ogni situazione e una velocità controllata sotto carico. Progettato in modo particolare per soddisfare le esigenze specifiche dei mezzi pesanti con sospensioni pneumatiche di ultima generazione per le operazioni dove la compattezza e la potenza sono un'esigenza.

Air hydraulic jack for heavy vehicles, practical and easy to handle. The pistons move back automatically; the two descent valves guarantee perfect holding in all situations and controlled speed under load. Designed especially to meet the specific needs of heavy vehicles with pneumatic suspensions of the latest generation for jobs where a compact size and power are a must.

ACCESSORI DI SERIE - STANDARD ACCESSORIES





YAK 215/L

YAK 315/L

YAK 215/L

YAK 315/L

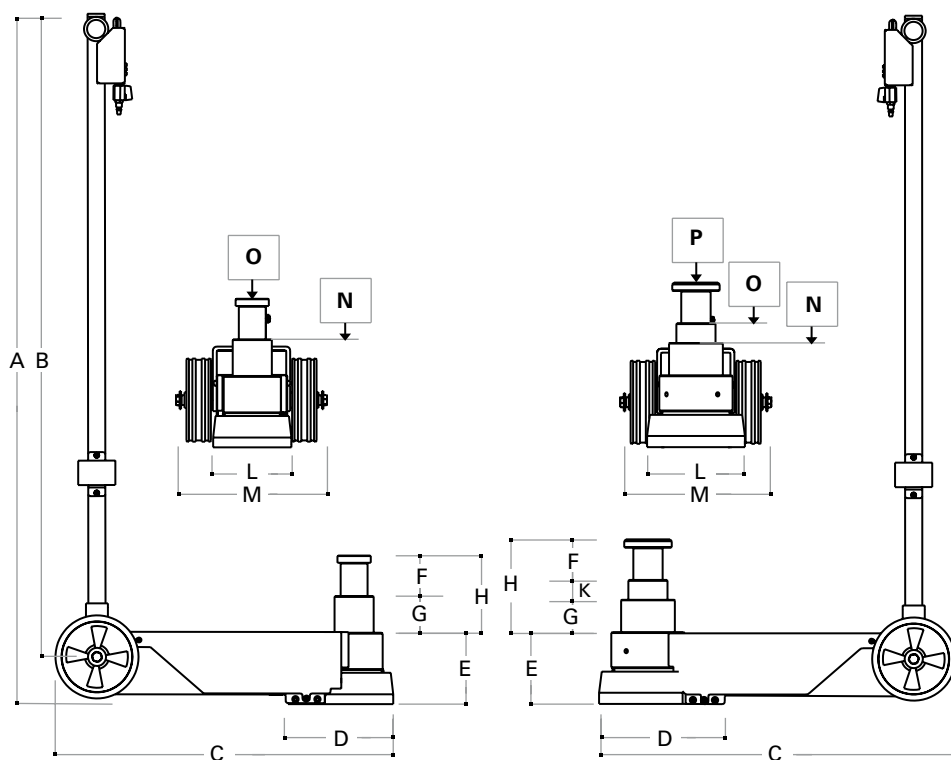

	YAK 215/L	YAK 315/L
Portata Capacity	40/20 t 44/22 ton	60/30/18 t 66/33/20 ton
Peso netto Net weight	39 kg 86 lb	46 kg 101 lb
Pressione di alimentazione Working air pressure	8-10 bar 116-145 psi	8-10 bar 116-145 psi
Consumo d'aria Air waste	400 nl/min	400 nl/min
A	1400 mm 55.12 in	1400 mm 55.12 in
B	1320 mm 51.97 in	1320 mm 51.97 in
C	700 mm 27.56 in	730 mm 28.74 in
D	210 mm 8.27 in	250 mm 9.84 in
E	150 mm 5.91 in	150 mm 5.91 in
F	78 mm 3.07 in	66 mm 2.6 in
G	72 mm 2.83 in	63 mm 2.48 in
H	150 mm 5.91 in	185 mm 7.28 in
K		56 mm 2.2 in
L	150 mm 5.91 in	200 mm 7.87 in
M	300 mm 11.81 in	300 mm 11.81 in
N	40 t 44 ton	60 t 66 ton
O	20 t 22 ton	30 t 33 ton
P		18 t 20 ton