









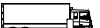
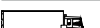
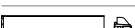

# SOLLEVATORE OLEOPNEUMATICO PORTATILE

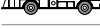
## AIR HYDRAULIC PORTABLE JACK

	Mod.		
	YAK 215/P	YAK 217/P	YAK 221/P
	•	•	
	•	•	•
	•	•	•
	•	•	•
	•	•	•
	•	•	•
	•	•	•
			•
			•
			•
	•		
	•		
	•		

Sollevatore Oleopneumatico per mezzi pesanti, leggero e maneggevole, con manico smontabile. Rientro automatico dei pistoni; le due valvole di discesa garantiscono una tenuta perfetta in ogni situazione e una velocità controllata sotto carico. La nostra serie portatile per "eccellenza", tutta l'efficacia e la praticità dei nostri sollevatori in una versione più compatta. Ideali da tenere a bordo del mezzo e per chi svolge assistenza su strada. Possono funzionare con i compressori di bordo dei mezzi.

*Air hydraulic jacks for heavy vehicles, lightweight and easy to handle, with removable handle. The pistons move back automatically; the two descent valves guarantee perfect holding in all situations and controlled speed under load. Our portable series par "excellence", all the reliability and practicality of our jacks in a more compact version. Ideal for keeping on board the vehicle and for who provides road assistance. They can work with the vehicles' own compressors.*

### ACCESSORI DI SERIE - STANDARD ACCESSORIES



# YAK 215/P

# YAK 217/P

# YAK 221/P



YAK 215/P

YAK 217/P

YAK 221/P

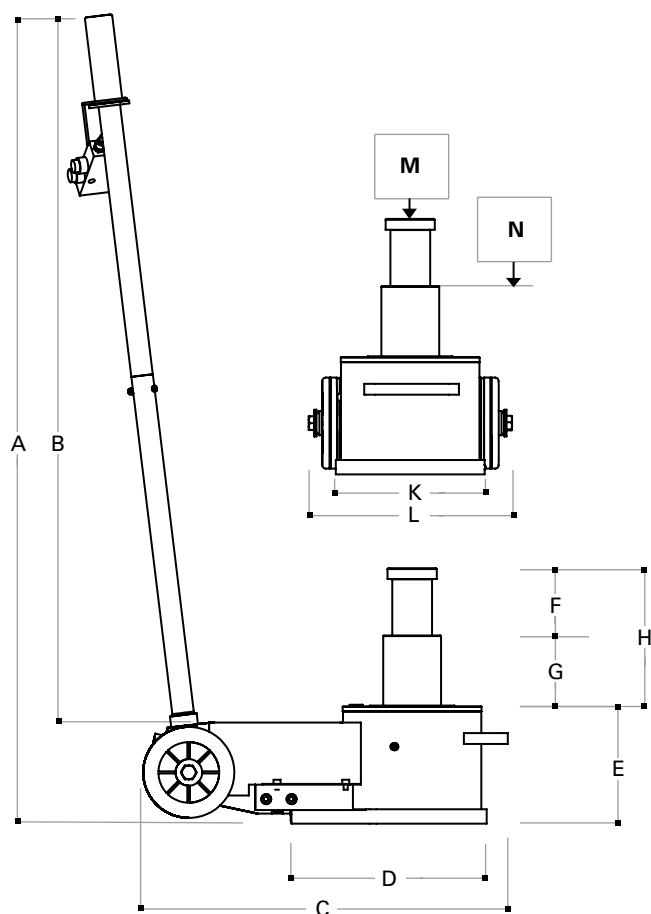

	YAK 215/P	YAK 217/P	YAK 221/P
Portata Capacity	40/20 t 44/22 ton	40/20 t 44/22 ton	40/20 t 44/22 ton
Peso netto Net weight	35 kg 77 lb	37 kg 82 lb	42 kg 93 lb
Pressione di alimentazione Working air pressure	8-10 bar 116-145 psi	8-10 bar 116-145 psi	8-10 bar 116-145 psi
Consumo d'aria Air waste	400 nl/min	400 nl/min	400 nl/min
<b>A</b>	1100 mm 43.31 in	1100 mm 43.31 in	1100 mm 43.31 in
<b>B</b>	985 mm 38.78 in	985 mm 38.78 in	985 mm 38.78 in
<b>C</b>	500 mm 16.69 in	500 mm 16.69 in	500 mm 16.69 in
<b>D</b>	270 mm 10.63 in	270 mm 10.63 in	270 mm 10.63 in
<b>E</b>	150 mm 5.91 in	170 mm 6.69 in	217 mm 8.54 in
<b>F</b>	78 mm 3.07 in	88 mm 3.46 in	126 mm 4.96 in
<b>G</b>	72 mm 2.83 in	83 mm 3.27 in	124 mm 4.88 in
<b>H</b>	150 mm 5.91 in	171 mm 6.73 in	250 mm 8.54 in
<b>K</b>	206 mm 8.11 in	206 mm 8.11 in	206 mm 8.11 in
<b>L</b>	300 mm 11.81 in	300 mm 11.81 in	300 mm 11.81 in
<b>M</b>	20 t 22 ton	20 t 22 ton	20 t 22 ton
<b>N</b>	40 t 44 ton	40 t 44 ton	40 t 44 ton