















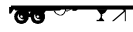

SOLLEVATORI IDRAULICI A CARRELLO HYDRAULIC TROLLEY JACKS

Sollevatori idraulici manuali carrellati. L'azionamento manuale della pompa avviene attraverso il movimento del manico. Sui modelli "Q" è presente inoltre l'avvicinamento rapido a pedale. Leggeri e maneggevoli, ideali per gommisti, officine e carrozzerie.

*Manual hydraulic trolley jacks.
The pump is manually operated by handle movement. The pedal control on "Q" models is used for a quick approach. Lightweight and easy to handle, ideal for tyre repairers, workshops and bodywork shops.*



Mod.

	YAK 40/Q	YAK 50/QL	YAK 60/Q	YAK 100/Q
	•			
	•			
	•	•	•	•
	•	•	•	•
	•	•	•	•
				•
		•	•	•
			•	•
				•
	•	•	•	•
			•	•
				•
	•	•	•	•
				•
				•
				•



YAK 40/Q

YAK 50/QL

YAK 60/Q

YAK 100/Q



YAK 40/Q

YAK 50/QL

YAK 60/Q

YAK 100/Q

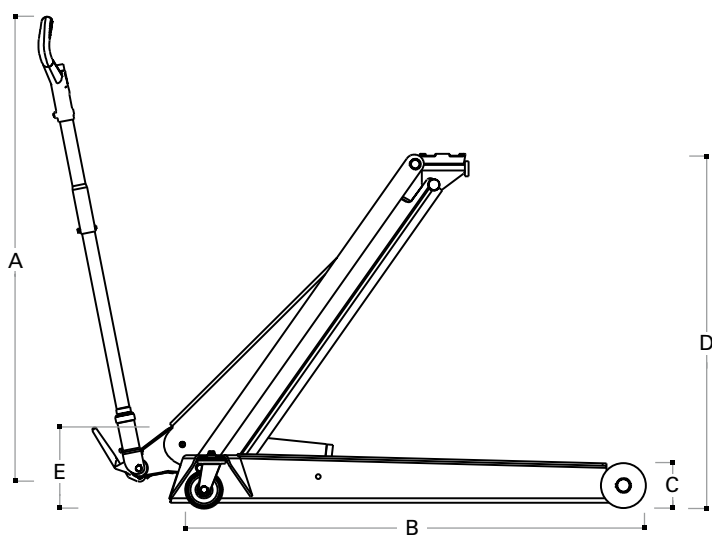

	YAK 40/Q	YAK 50/QL	YAK 60/Q	YAK 100/Q
Portata Capacity	4 t 4.4 ton	5 t 5.5 ton	6 t 6.6 ton	10 t 11 ton
Peso netto Net weight	88 kg 194 lb	170 kg 375 lb	95 kg 209 lb	118 kg 260 lb
A	950 mm 37.40 in	1200 mm 47.24 in	1200 mm 47.24 in	1200 mm 47.24 in
B	800 mm 31.5 in	1290 mm 50.79 in	800 mm 31.5 in	805 mm 31.69 in
C	140 mm 5.51 in	140 mm 5.51 in	140 mm 5.51 in	150 mm 5.91 in
D	600 mm 23.62 in	975 mm 38.29 in	600 mm 23.62 in	585 mm 23.03 in
E	240 mm 9.45 in	265 mm 10.43 in	240 mm 9.45 in	260 mm 10.24 in