



WULKAN

Wheel Washers

since
1977





WULKAN Wheel Washers

About KART

For 38 years we have been active on the market of garage equipment. For 16 years we have been specialising in manufacturing of automatic wheel washers. We are the sole manufacturer of wheel washers in Poland and one of the leading manufacturers of such machines in the world. Our wheel washers are already used in 35 countries. We are the first to introduce the integrated water heating system. The models that were specifically designed for truck wheels are absolutely unique in the world. We are proud of the high quality and reliability of our wheel washers. This is why WULKAN is the recognizable and highly regarded brand, and the number of



our customers in Poland and abroad is constantly increasing. Our motto is innovation, permanent development and improvement which help our products meet and satisfy the constantly changing needs and requirements of our customers. Our advantage is flexibility which helps us compete effectively on this demanding market. This is why KART is a recognizable and highly regarded trademark. The Company's seat is located in Warsaw. Our products are offered to customers in Poland and abroad through a network of distributors. The premium quality of our products is guaranteed and confirmed by a CE mark. We are also the ISO 9001-2008 Quality Certified.

About WULKAN wheel washers

A wheel washer is a machine which supports servicing of wheels. It is used for technological washing of full car wheels, consisting of the rim and the tyre. The efficiency of technological washing in the WULKAN wheel washers is sufficient for the wheel to be subjected to any servicing activities and meets the necessary requirements in this scope. Using the wheel washer for washing the wheel before servicing activities such as balancing makes the job more precise. This translates directly into safety and comfort of driving.

All our wheel washers have the following features:

- they are fully automatic
- they use the washing method consisting in striking the wheel with a pressurized mixture of water and the WULKAN MIX granulate, with addition of the WULKAN TURBO washing concentrate
- they operate in a closed-circuit water system

- they use the natural self-cleaning method based on sedimentation phenomenon
- they are easy to install and operate
- they save energy
- they are equipped with ergonomic housing
- they are environmentally friendly

Benefits of WULKAN wheel washers:

- high efficiency of the washing process
- easier and more precise servicing operations
- improved driving safety and comfort
- cleaner and neater workshop
- prolonged lifetime of service equipment
- better work environment for the personnel
- working time more effectively used
- improved quality of customer service
- low operating costs

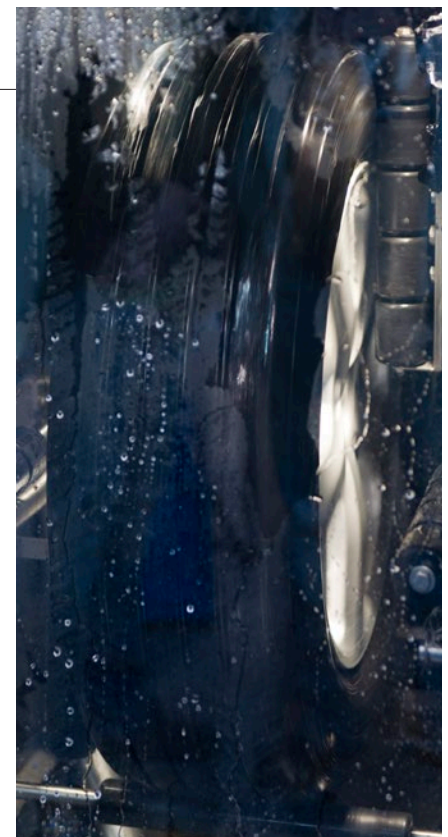

WULKAN 200



WULKAN
Wheel Washers

for all types of wheels for passenger cars and vans
with any type of rims and tyres

GENERAL FEATURES

- triple acoustic insulation system (rubber lining, perforated PVC shield, foam)
- anti-vibration rubber feet
- possible adjusting of washing and drying times in the production stage
- counter of starts display option available
- attractive graphic design on request

STANDARD EQUIPMENT

- WULKAN MIX granulate 25 kg
- granulate basket
- WULKAN TURBO washing concentrate 20 l
- plastic protective cover



TECHNICAL DATA

Wheel diameter range	560 - 800 mm
Wheel width range	135 - 305 mm
Maximum weight of wheel	60 kg
Washing times, factory set (adjustable, 3 programmes)*	20, 40, 60 sec
Drying time, factory set (adjustable, 1 programme)**	15 sec
Pump drive 3-phase 400 V, 50 Hz, 5.5 kW	2900 rpm
Pump efficiency	600 lpm
Wheel drive 3-phase 400 V, 50 Hz, 0.37 kW	930 rpm
Motors and drive power	6 kW
Water pressure	4 bar
Quantity of water	150 l
Quantity of WULKAN MIX granulate	17.5 kg
Quantity of WULKAN TURBO washing concentrate	1.5 l
Compressed air working pressure	8 - 12 bar
Average sound level	78.0 dB(A)
Dimensions (width x depth x height)	900 x 910 x 1360 mm
Net weight	270 kg
Maximum limiting number of washing process starts (service lock)	200 starts

*/**adjustable only in the production stage

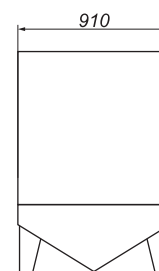
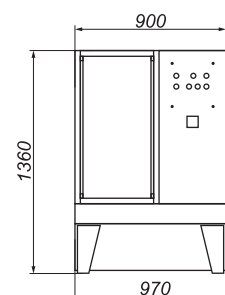

WULKAN 300



WULKAN
Wheel Washers

for all types of wheels for passenger cars and vans
with any type of rims and tyres

GENERAL FEATURES

- sedimentation tank separated from washing chamber
- triple acoustic insulation system (rubber lining, perforated PVC shield, foam)
- anti-vibration rubber feet
- possible adjusting of washing and drying times in the production stage
- counter of starts display option available
- attractive graphic design on request
- externally mounted water heating system available for retrofitting in older versions of machine

STANDARD EQUIPMENT

- WULKAN MIX granulate 25 kg
- granulate basket
- WULKAN TURBO washing concentrate 30 l
- plastic protective cover



TECHNICAL DATA

Wheel diameter range	560 - 800 mm
Wheel width range	135 - 305 mm
Maximum weight of wheel	60 kg
Washing times, factory set (adjustable, 3 programmes)*	20, 40, 60 sec
Drying time, factory set (adjustable, 1 programme)**	15 sec
Pump drive 3-phase 400 V, 50 Hz, 5.5 kW	2900 rpm
Pump efficiency	600 lpm
Wheel drive 3-phase 400 V, 50 Hz, 0.37 kW	930 rpm
Motors and drive power	6 kW
Water pressure	4 bar
Quantity of water	300 l
Quantity of WULKAN MIX granulate	20 kg
Quantity of WULKAN TURBO washing concentrate	3 l
Compressed air working pressure	8 - 12 bar
Average sound level	78.4 dB(A)
Dimensions (width x depth x height)	900 x 1210 x 1450 mm
Net weight	310 kg
Maximum limiting number of washing process starts (service lock)	500 starts

*/**adjustable only in the production stage

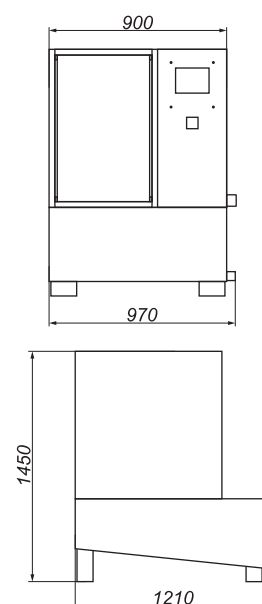

WULKAN 300H

for all types of wheels for passenger cars and vans with any type of rims and tyres, with water heating system

GENERAL FEATURES

- computer control
- software in 6 languages
- user-friendly display
- sedimentation tank separated from washing chamber
- triple acoustic insulation system (rubber lining, perforated PVC shield, foam)
- anti-vibration rubber feet
- attractive graphic design on request

HEATING SYSTEM

- heater power - 4 kW 400 V
- water heating time to 50°C: 60 - 120 min
- overheating protection

STANDARD EQUIPMENT

- WULKAN MIX granulate 25 kg
- granulate basket
- WULKAN TURBO washing concentrate 30 l
- plastic protective cover
- air blow gun

TECHNICAL DATA

Wheel diameter range	560 - 800 mm
Wheel width range	135 - 305 mm
Maximum weight of wheel	60 kg
Washing times, factory set (adjustable, 3 programmes)	20, 40, 60 sec
Drying time, factory set (adjustable, 1 programme)	15 sec
Water heating time to 50°C	60 - 120 min
Heater power	4 kW 400 V
Pump drive 3-phase 400 V, 50 Hz, 5.5 kW	2900 rpm
Pump efficiency	600 lpm
Wheel drive 3-phase 400 V, 50 Hz, 0.37 kW	930 rpm
Motors and drive power	6 kW
Water pressure	4 bar
Quantity of water	300 l
Quantity of WULKAN MIX granulate	20 kg
Quantity of WULKAN TURBO washing concentrate	3 l
Compressed air working pressure	8 - 12 bar
Average sound level	78.4 dB(A)
Dimensions (width x depth x height)	900 x 1210 x 1450 mm
Net weight	310 kg
Maximum limiting number of washing process starts (service lock)	500 starts



WULKAN
Wheel Washers

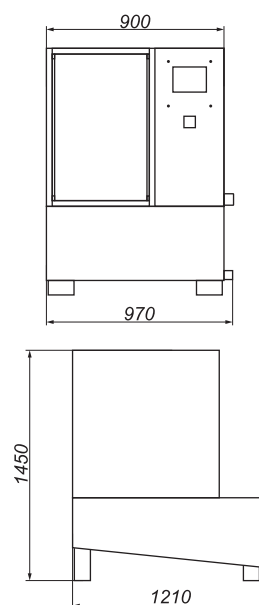

WULKAN 360P



WULKAN
Wheel Washers

for all types of wheels for passenger cars, vans, off-road vehicles and SUVs up to 360 mm wide with any type of rims and tyres, with pneumatic wheel stabilisation system

GENERAL FEATURES

- servomotor with an arm keeping narrower wheels in vertical position
- sedimentation tank separated from washing chamber
- triple acoustic insulation system (rubber lining, perforated PVC shield, foam)
- anti-vibration rubber feet
- possible adjusting of washing and drying times in the production stage
- counter of starts display option available
- attractive graphic design on request
- shut-off ball valve

STANDARD EQUIPMENT

- WULKAN MIX granulate 25 kg
- granulate basket
- WULKAN TURBO washing concentrate 30 l
- plastic protective cover
- rubber anti slip mat 2 pcs
- air blow gun

OPTIONAL ACCESSORIES

- pneumatic wheel lift



TECHNICAL DATA

Wheel diameter range	560 - 800 mm
Wheel width range	135 - 360 mm
Maximum weight of wheel	60 kg
Washing times, factory set (adjustable, 3 programmes)*	20, 40, 60 sec
Drying time, factory set (adjustable, 1 programme)**	15 sec
Pump drive 3-phase 400 V, 50 Hz, 5.5 kW	2900 rpm
Pump efficiency	600 lpm
Wheel drive 3-phase 400 V, 50 Hz, 0.37 kW	930 rpm
Motors and drive power	6 kW
Water pressure	4 bar
Quantity of water	300 l
Quantity of WULKAN MIX granulate	20 kg
Quantity of WULKAN TURBO washing concentrate	3 l
Compressed air working pressure	8 - 12 bar
Average sound level	79.5 dB(A)
Dimensions (width x depth x height)	960 x 1210 x 1450 mm
Net weight	330 kg
Maximum limiting number of washing process starts (service lock)	500 starts

*/**adjustable only in the production stage

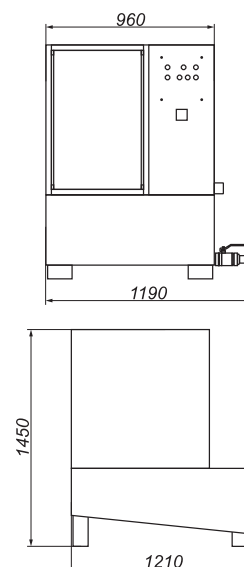

WULKAN 360HP



WULKAN
Wheel Washers

for all types of wheels for passenger cars, vans, off-road vehicles and SUVs up to 360 mm wide with any type of rims and tyres, with water heating system and pneumatic wheel stabilisation system

GENERAL FEATURES

- computer control
- software in 6 languages
- user-friendly display
- servomotor with an arm keeping narrower wheels in vertical position
- sedimentation tank separated from washing chamber
- triple acoustic insulation system (rubber lining, perforated PVC shield, foam)
- anti-vibration rubber feet
- attractive graphic design
- also available in a mobile version on wheels
- shut-off ball valve

HEATING SYSTEM

- heater power - 4 kW 400 V
- water heating time to 50°C: 60 - 120 min
- overheating protection

STANDARD EQUIPMENT

- WULKAN MIX granulate 25 kg
- granulate basket
- WULKAN TURBO washing concentrate 30 l
- plastic protective cover
- rubber anti slip mat 2 pcs
- air blow gun

OPTIONAL ACCESSORIES

- pneumatic wheel lift

TECHNICAL DATA

Wheel diameter range	560 - 800 mm
Wheel width range	135 - 360 mm
Maximum weight of wheel	60 kg
Washing times, factory set (adjustable, 3 programmes)	20, 40, 60 sec
Drying time, factory set (adjustable, 1 programme)	15 sec
Water heating time to 50°C	60 - 120 min
Heater power	4 kW 400 V
Pump drive 3-phase 400 V, 50 Hz, 5.5 kW	2900 rpm
Pump efficiency	600 lpm
Wheel drive 3-phase 400 V, 50 Hz, 0.37 kW	930 rpm
Motors and drive power	6 kW
Water pressure	4 bar
Quantity of water	300 l
Quantity of WULKAN MIX granulate	20 kg
Quantity of WULKAN TURBO washing concentrate	3 l
Compressed air working pressure	8 - 12 bar
Average sound level	79.5 dB(A)
Dimensions (width x depth x height)	960 x 1210 x 1450 mm
Net weight	330 kg
Maximum limiting number of washing process starts (service lock)	500 starts

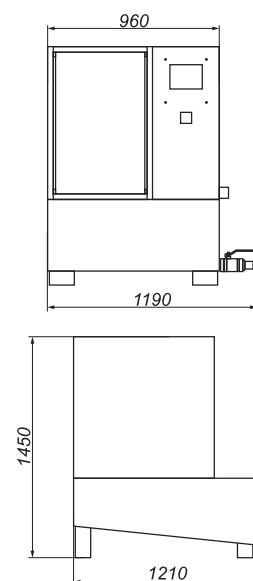

WULKAN 4x4HP

for all types of wheels for passenger cars, vans, off-road vehicles and SUVs up to 360 mm wide with the diameter of up to 850 mm with any type of rims and tyres, with water heating system and pneumatic wheel stabilisation system

GENERAL FEATURES

- computer control
- software in 6 languages
- user-friendly display
- servomotor with an arm keeping narrower wheels in vertical position
- sedimentation tank separated from washing chamber
- double acoustic insulation system (rubber lining, foam)
- anti-vibration rubber feet
- attractive graphic design
- shut-off ball valve

HEATING SYSTEM

- heater power - 4 kW 400 V
- water heating time to 50°C: 60 - 120 min
- overheating protection

STANDARD EQUIPMENT

- WULKAN MIX granulate 25 kg
- granulate basket
- WULKAN TURBO washing concentrate 30 l
- plastic protective cover
- rubber anti slip mat 2 pcs
- air blow gun

OPTIONAL ACCESSORIES

- pneumatic wheel lift

TECHNICAL DATA

Wheel diameter range	560 - 850 mm
Wheel width range	135 - 360 mm
Maximum weight of wheel	60 kg
Washing times, factory set (adjustable, 3 programmes)	20, 40, 60 sec
Drying time, factory set (adjustable, 1 programme)	15 sec
Water heating time to 50°C	60 - 120 min
Heater power	4 kW 400 V
Pump drive 3-phase 400 V, 50 Hz, 5.5 kW	2900 rpm
Pump efficiency	600 lpm
Wheel drive 3-phase 400 V, 50 Hz, 0.55 kW	930 rpm
Motors and drive power	6 kW
Water pressure	4 bar
Quantity of water	300 l
Quantity of WULKAN MIX granulate	20 kg
Quantity of WULKAN TURBO washing concentrate	3 l
Compressed air working pressure	8 - 12 bar
Average sound level	79.1 dB(A)
Dimensions (width x depth x height)	960 x 1210 x 1510 mm
Net weight	330 kg
Maximum limiting number of washing process starts (service lock)	500 starts



WULKAN
Wheel Washers

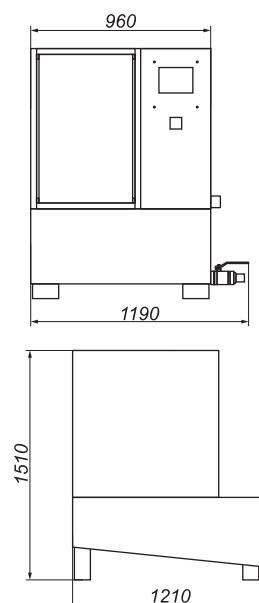

WULKAN 500H



WULKAN
Wheel Washers

for all types of bus and truck wheels with any type of rims and tyres, with water heating system and pneumatic wheel loading and unloading system

GENERAL FEATURES

- computer control
- software in 6 languages
- user-friendly display
- pneumatic rotary lift
- sedimentation tank separated from washing chamber
- double acoustic insulation system (rubber lining, foam)
- anti-vibration rubber feet
- locking handle for washing chamber flap
- functional shelf for accessories
- attractive graphic design
- shut-off ball valve

HEATING SYSTEM

- heater power - 4 kW 400 V
- water heating time to 50°C: 120 - 180 min
- overheating protection

STANDARD EQUIPMENT

- WULKAN MIX granulate 50 kg
- granulate basket
- WULKAN TURBO washing concentrate 50 l
- rubber anti slip mat 3 pcs
- air blow gun

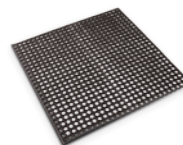

TECHNICAL DATA

Wheel diameter range	740 - 1200 mm
Wheel width range	240 - 430 mm
Maximum weight of wheel	150 kg
Washing times, factory set (adjustable, 3 programmes)	60, 120, 240 sec
Drying time, factory set (adjustable, 1 programme)	30 sec
Water heating time to 50°C	120 - 180 min
Heater power	4 kW 400 V
Pump drive 3-phase 400 V, 50 Hz, 5.5 kW	2900 rpm
Pump efficiency	600 lpm
Wheel drive 3-phase 400 V, 50 Hz, 1.1 kW	700 rpm
Motors and drive power	7 kW
Water pressure	4 bar
Quantity of water	500 l
Quantity of WULKAN MIX granulate	40 kg
Quantity of WULKAN TURBO washing concentrate	5 l
Compressed air working pressure	8 - 12 bar
Average sound level	78.3 dB(A)
Dimensions (width x depth x height)	1080 x 1600 x 2170 mm
Net weight	630 kg
Maximum limiting number of washing process starts (service lock)	200 starts

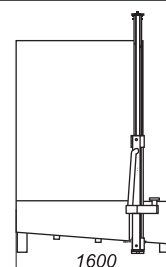
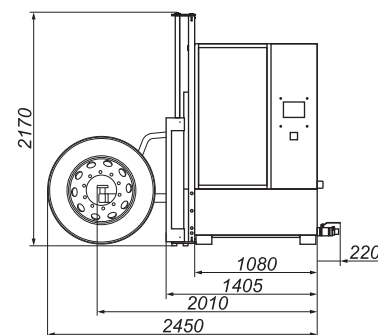

WULKAN 500HP



WULKAN
Wheel Washers

for all types of bus and truck wheels up to 490 mm wide with any type of rims and tyres, with water heating system and pneumatic wheel loading and unloading system, with additional pneumatic wheel push-out system

GENERAL FEATURES

- computer control
- software in 6 languages
- user-friendly display
- pneumatic rotary lift
- pneumatic system pushing the wheel from washing chamber
- sedimentation tank separated from washing chamber
- double acoustic insulation system (rubber lining, foam)
- anti-vibration rubber feet
- locking handle for washing chamber flap
- functional shelf for accessories
- attractive graphic design
- shut-off ball valve

HEATING SYSTEM

- heater power - 4 kW 400 V
- water heating time to 50°C: 120 - 180 min
- overheating protection

STANDARD EQUIPMENT

- WULKAN MIX granulate 50 kg
- granulate basket
- WULKAN TURBO washing concentrate 50 l
- rubber anti slip mat 3 pcs
- air blow gun

TECHNICAL DATA

Wheel diameter range	740 - 1200 mm
Wheel width range	240 - 490 mm
Maximum weight of wheel	150 kg
Washing times, factory set (adjustable, 3 programmes)	60, 120, 240 sec
Drying time, factory set (adjustable, 1 programme)	30 sec
Water heating time to 50°C	120 - 180 min
Heater power	4 kW 400 V
Pump drive 3-phase 400 V, 50 Hz, 5.5 kW	2900 rpm
Pump efficiency	600 lpm
Wheel drive 3-phase 400 V, 50 Hz, 1.1 kW	700 rpm
Motors and drive power	7 kW
Water pressure	4 bar
Quantity of water	500 l
Quantity of WULKAN MIX granulate	40 kg
Quantity of WULKAN TURBO washing concentrate	5 l
Compressed air working pressure	8 - 12 bar
Average sound level	78.3 dB(A)
Dimensions (width x depth x height)	1140 x 1600 x 2170 mm
Net weight	680 kg
Maximum limiting number of washing process starts (service lock)	200 starts

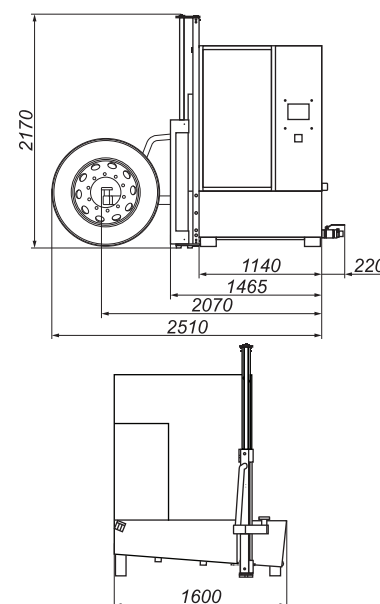
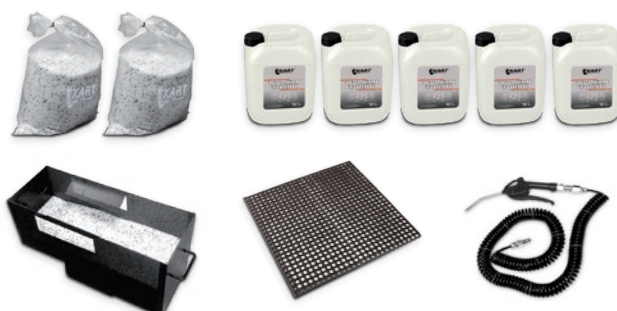

Consumables



WULKAN MIX granulate 25 kg

This is a mixture of specially selected small round pieces made of biodegradable plastic, with various diameters, weight and hardness. Due to diverse weights and diameters, the pieces distribute uniformly in water in the form of a suspension. The mixture was developed by the KART Company based on many years of experience and tests and ensures the best washing effect without damaging the wheel rim. During washing and cleaning of the washer almost all granulate is recovered. To ensure correct operation of the washer and the best washing results it is important to keep the required level of the working medium. The WULKAN MIX granulate due to its properties practically does not wear out; it is only necessary to add some granulate in order to keep its required quantity in the washing mixture.



WULKAN TURBO washing concentrate 10 l

It is the non-foaming, biodegradable washing agent specially designed and manufactured for the KART Company and used for improving the quality of washing operation. Apart from the components that dissolve various types of dirt and grease deposited on the tyre and rim, the concentrate also contains a Calgonit preparation used for dishwashing machines; this preparation additionally makes the rim shiny. Using the washing concentrate also helps keep the washing machine clean, since it prevents dirt from sticking to the washing chamber walls, thus making the washer cleaning operation much easier. The concentrate is to be diluted in the proportion of 1:100. When topping up the water during washer operation, it is important not to forget adding the respective quantity of concentrate. The washing concentrate is the optional washing agent recommended by the KART Company. When a proper proportion is maintained, the WULKAN TURBO concentrate dissolves in water and then can be safely drained to the sewerage system.

Accessories

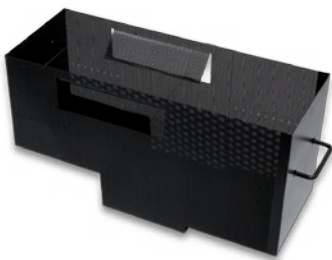

Granulate basket



Plastic protective cover

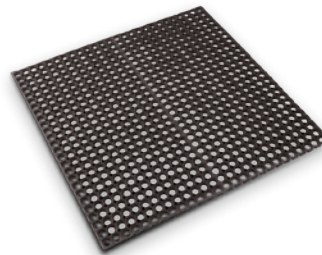

Rubber anti slip mat



Air blow gun

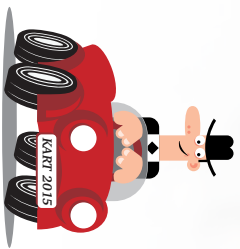

COMPARISON OF MODELS

	WULKAN 200	WULKAN 300	WULKAN 300H	WULKAN 360P	WULKAN 360HP	WULKAN 4x4HP	WULKAN 500H	WULKAN 500HP
Wheel diameter range	560 – 800 mm	560 – 800 mm	560 – 800 mm	560 – 800 mm	560 – 800 mm	560 – 850 mm	740 – 1200 mm	740 – 1200 mm
Wheel width range	135 – 305 mm	135 – 305 mm	135 – 305 mm	135 – 360 mm	135 – 360 mm	135 – 360 mm	240 – 430 mm	240 – 490 mm
Maximum weight of wheel	60 kg	60 kg	60 kg	60 kg	60 kg	60 kg	150 kg	150 kg
Washing times (factory set)	20, 40, 60 sec	20, 40, 60 sec	20, 40, 60 sec	20, 40, 60 sec	20, 40, 60 sec	20, 40, 60 sec	60, 120, 240 sec	60, 120, 240 sec
Drying time (factory set)	15 sec	15 sec	15 sec	15 sec	15 sec	15 sec	30 sec	30 sec
Water heating time to 50°C			60 – 120 min			60 – 120 min	120 – 180 min	120 – 180 min
Heater power			4 kW 400 V			4 kW 400 V	4 kW 400 V	4 kW 400 V
Pump drive 3-phase 400 V, 50 Hz, 5.5 kW	2900 rpm	2900 rpm	2900 rpm	2900 rpm	2900 rpm	2900 rpm	2900 rpm	2900 rpm
Pump efficiency	600 lpm	600 lpm	600 lpm	600 lpm	600 lpm	600 lpm	600 lpm	600 lpm
Wheel drive 3-phase 400 V, 50 Hz, 0.37 kW (WULKAN 4x4HP – 0.55 kW, WULKAN 500H/HP – 1.1 kW)	930 rpm	930 rpm	930 rpm	930 rpm	930 rpm	930 rpm	700 rpm	700 rpm
Motors and drive power	6 kW	6 kW	6 kW	6 kW	6 kW	6 kW	7 kW	7 kW
Water pressure	4 bar	4 bar	4 bar	4 bar	4 bar	4 bar	4 bar	4 bar
Quantity of water	150 l	300 l	300 l	300 l	300 l	300 l	500 l	500 l
Quantity of WULKAN MIX granulate	17.5 kg	20 kg	20 kg	20 kg	20 kg	20 kg	40 kg	40 kg
Quantity of WULKAN TURBO washing concentrate	1.5 l	3 l	3 l	3 l	3 l	3 l	5 l	5 l
Compressed air working pressure	8 – 12 bar	8 – 12 bar	8 – 12 bar	8 – 12 bar	8 – 12 bar	8 – 12 bar	8 – 12 bar	8 – 12 bar
Average sound level	78.0 dB(A)	78.4 dB(A)	78.4 dB(A)	79.5 dB(A)	79.5 dB(A)	79.1 dB(A)	78.3 dB(A)	78.3 dB(A)
Dimensions (width x depth x height)	900 x 910 x 1360 mm	900 x 1210 x 1450 mm	900 x 1210 x 1450 mm	960 x 1210 x 1450 mm	960 x 1210 x 1450 mm	960 x 1210 x 1510 mm	1080 x 1600 x 2170 mm	1140 x 1600 x 2170 mm
Net weight	270 kg	310 kg	310 kg	330 kg	330 kg	330 kg	630 kg	680 kg
Maximum limiting number of washing process starts (service lock)	200 starts	500 starts	500 starts	500 starts	500 starts	500 starts	200 starts	200 starts



WULKAN
Wheel Washers



KART

Bychowska 22, PL-04-523 Warszawa, Poland
Tel.: +48 22 812 55 05; Fax: +48 22 812 54 04
info@kart.pl; www.kart.pl

