

09/23



Lifting Changing Balancing Equipment



ATH SmartKat



1-post lifts



2-post lifts



4-post lifts



Mid-rise lifts



Car tire changers



Truck tire changers



Platform-scissor lifts



Double-scissor lifts



Motorcycle lifts



Mobile column lifts



Car wheel balancers



Truck wheel balancers



About ATH-Heinl



ATH-Headquarter

Welcome to the Upper Palatinate! Our company headquarters are located directly on the A6 motorway between Nuremberg and Amberg. The innovative company headquarters opened in 2019 and comprises of 9,400 m² of workspace, training, and storage area.

Thanks to the new office concept, digital and agile work is implemented efficiently. The warehouse for goods and spare parts enables a high level of delivery availability. On the 38,000 square meter company premises, we can quickly and simply create more storage capacity for our growth-oriented company.



ATH-Academy

With the practical training concept of the „ATH Academy“ on an area of 700 m², salesmen and fitters are trained by ATH, in order to expand their knowledge base. For this purpose the participants have an extra classroom for the theoretical part, including all ATH machines fully operational to test / use. In addition, there is a showroom for potential customers and the possibility of getting into and `feel` the units before purchasing, introducing themselves into the best `fit` product.



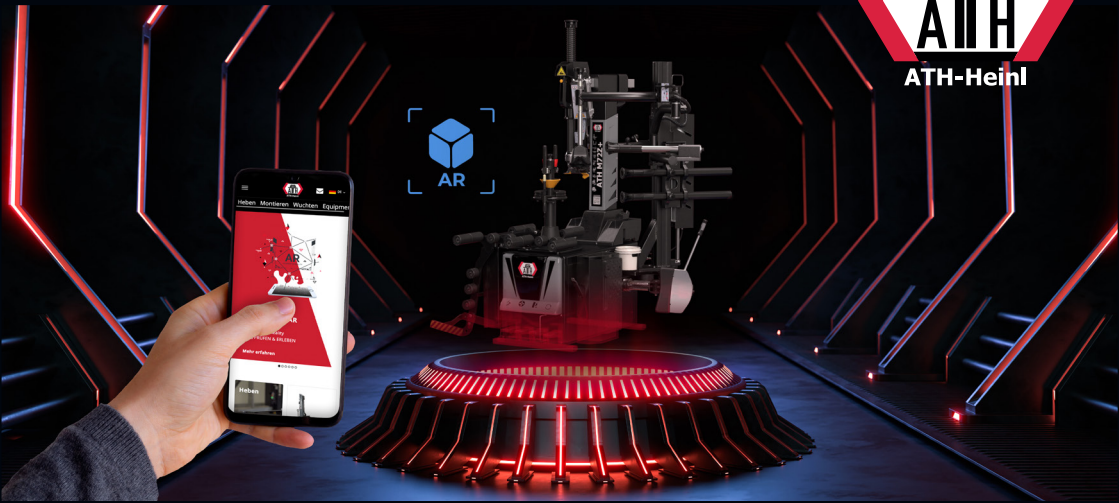

Interactive ATH-Customer platform

With many new tools and features, our website invites workshops and sales partners to visit, and to provide an overview of our products. Especially, our 360 ° videos in combination with the new ATH Augmented Reality makes it possible to get to know our machines in advance. The website expands into an interactive customer platform, step by step. In future, this and many other things will connect the digital world and internal processes of the company. **ATH-AR READY:** <https://www.ath-heinl.com/ar>

ATH-Team

A team of specialists for your Workshop equipment.

Held as a family business that Mr. Hans Heintl and Mrs. Evi Heintl founded 30 years ago, since 2007 - rest of the family - Anja, Corinna and Fabian Heintl joined the management. With culture, strength, and constancy an owner-managed company ATH-Heinl became one the European leader in the Workshop equipment.





Up to 3 years guarantee

The extension of the manufacturer's warranty up to 3 years only applies in connection with installation and maintenance contract with certified ATH sales partner.

More information about the guarantee requirements and the scope of the agreement can be obtained from our sales department.

Here you will find everything for your ATH-Heinl machine.



Accessories



User manual

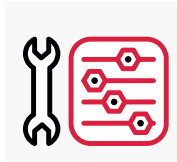

Spare parts

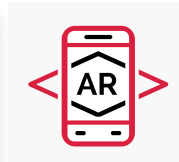

Augmented Reality / 3D



Service



Installation

Informative assembly and installation videos



2 SPEEDS

Work more efficiently:
We show the speeds



Calibration

Intuitive Calibration videos with all steps



Index

Lifting

06–49

1-post lifts	2.35 2.40 2.35XL 2.40XL 2.55XL Matrix Pure	06–15
2-post lifts	Single Lift 35M Single Lift 25M Single Lift 12PL	16–21
4-post lifts	Four Lift 55HP 55HAP 55AP 55P 46 64	22–29
Platform-scissor lifts	Cross Lift 35 40 50 Cross Lift Plus 40 50	30–35
Double-scissor lifts	Frame Lift 30FZ 30FZ UG 35FZ 35FZ UG	36–39
Mid-rise lifts	Flex Lift 30 Flex Lift 30Z	40–43
Motorcycle lifts	Bike Lift 7 Bike Lift 7F Bike Lift 7Q Bike Lift 7QF	44–45
Mobile column lifts	RG5.5 WB RG8.5 WB	46–49

Changing

50–69

Car tire changers	M72Z+ M72A34+ M72A34 M52A34 M52 M33A24 M33 M31	50–65
Truck tire changers	7256 7226	66–69

Balancing

70–87

Car wheel balancers	W82 Plus W82 3D W62 3D 2D W42 3D 2D W24	70–83
Truck wheel balancers	W142 W102	84–87

Equipment

88–91

Lifting table	T15	88–89
Wheel lift	RH120C	90
Axle jack	AF2500P2	91

Accessories

92–103



ATH Comfort Lift 2.35 | 2.40

- Electro-hydraulic 2-post lift with quick lift unit and load-dependent lowering function
- Two control units for flexible use on both columns
- Energy set (230V / compressed air / 12V) on the main post
- Safety Control: Electromagnetic safety locks that automatically unlock with lifting and lowering
- Safety Lock: ability to lock the load on to the safety mechanism
- Multifunctional mounting via 3-part support arms and double telescopic support plates
- Very low drive-over plate (height = 20mm) to protect hydraulic hose and synchronization cables

Technical details

Video

Rated load capacity	3.500 kg 4.000 kg
Lifting height max.	2.000 mm
Drive-through width	2.500 mm
Overall width	3.542 mm
Support arms parts	3 3
Motor power	3kW
Lifting/Lowering time	approx. 30s
Power supply voltage	3x 400V / C16A
Concrete strength	min. C20/25 4.000x2.000x 200 220 mm

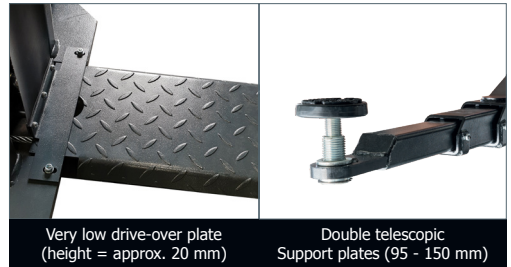

Accessories



User manual

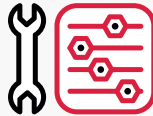

Spare parts



Augmented Reality / 3D



Service

PDF Product flyer

Item number

ATH Comfort Lift 2.35

622204

PDF Product flyer

Item number

ATH Comfort Lift 2.40

622210



ATH Comfort Lift

Item number: 622204 | 622210
ATH Comfort Lift: 2.35 | 2.40



Installation

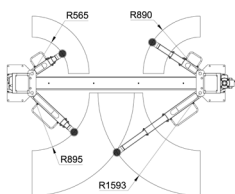

2.35

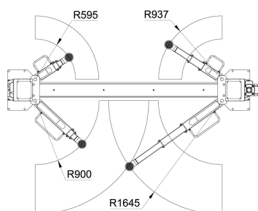

2.40

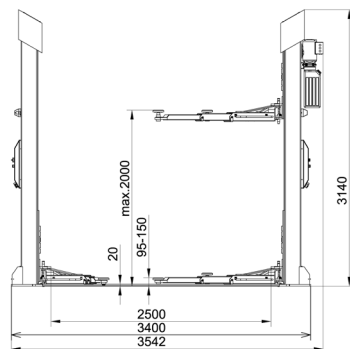

ATH Comfort Lift 2.35XL | 2.40XL

- Electro-hydraulic 2-post lift with quick lift unit and load-dependent lowering function
- Two control units for flexible use on both columns
- Energy set (230V / compressed air / 12V) on the main post
- Safety Control: Electromagnetic safety locks that automatically unlock with lifting and lowering
- Safety Lock: ability to lock the load on to the safety mechanism
- Multifunctional mounting via 3-part support arms and double telescopic support plates
- **Top-running crossbar with variable height adjustment**

Technical details	Video 
Rated load capacity	3.500 kg 4.000 kg
Lifting height max.	2.000 mm
Drive-through width	2.500 mm
Overall width	3.542 mm
Support arms parts	3 3
Motor power	3kW
Lifting/Lowering time	approx. 30s
Power supply voltage	3x 400V / C16A
Concrete strength	min. C20/25 4.000x2.000x 200 220 mm

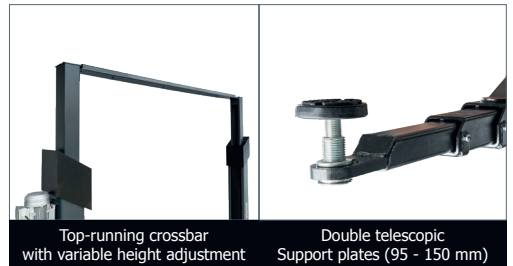

Accessories



User manual



Spare parts

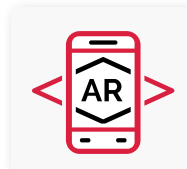

Augmented Reality / 3D



Service

PDF Product flyer

Item number

ATH Comfort Lift 2.35XL

622205

PDF Product flyer

Item number

ATH Comfort Lift 2.40XL

622207

ATH Comfort Lift

Item number: 622205 | 622207
 ATH Comfort Lift: 2.35XL | 2.40XL



Installation

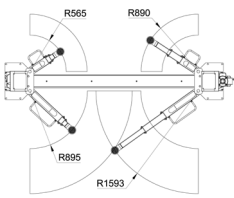

2.35XL

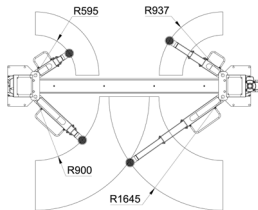

2.40XL

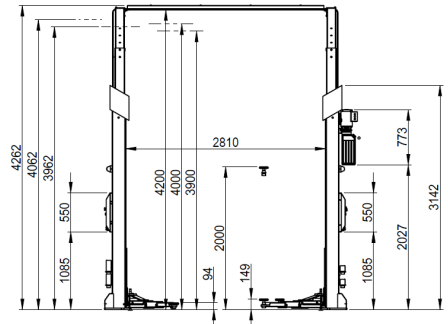

ATH Comfort Lift 2.55XL

- Electro-hydraulic 2-post lift with quick lift unit and load-dependent lowering function
- Two control units for flexible use on both columns
- Energy set (230V / compressed air / 12V) on both operating units
- Safety Control: Electromagnetic safety locks that automatically unlock with lifting and lowering
- Safety Lock: ability to lock the load on to the safety mechanism
- Multifunctional mounting via 3-part support arms and double telescopic support plates
- **Top-running crossbar with variable height adjustment**

Technical details

Rated load capacity	5.500 kg
Lifting height max.	1.950 mm
Drive-through width	2.650 mm
Overall width	3.500 mm
Support arms parts	3
Motor power	3kW
Lifting/Lowering time	approx. 40s
Power supply voltage	3x 400V / C16A
Concrete strength	min. C25/30 4.500x2.000x 220 mm



Energy set (230V / compressed air / 12V)
on both operating units



Top-running crossbar
with variable height adjustment

Double telescopic
Support plates (115-205mm)



Accessories



User manual



Spare parts



Augmented
Reality / 3D



Service

PDF Product flyer

Item number

ATH Comfort Lift 2.55XL

622222

ATH Comfort Lift 2.55XL

Item number: 622222

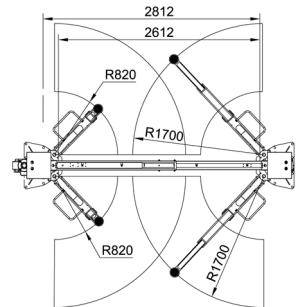
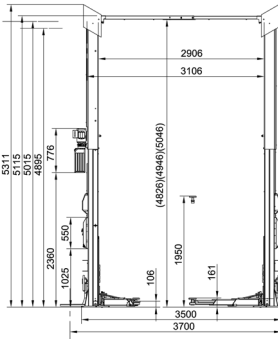

ATH Matrix Lift 2.65 | 2.75XL

- Electro-hydraulic 2-post lift with quick lift unit and load-dependent lowering function.
- **Synchro Control:** Special hydrosynchronous control for stepless synchronization without suspension ropes
- **Safety Control:** Electronically monitored synchronization and electromagnetic safety catches
- **Safety Lock:** Control for lowering the load into the safety catches
- 4-fold roller bearing lift carriage for optimal load transfer
- **Multifunctional pick-up via double articulated arms and telescopic carrying plates**
(from e.g. Smart to Sprinter/Crafter long wheel bases)
- **2.65** Without base frame and static connection, variable height adjustment
- **2.75XL** Top running crossbar with variable height adjustment

Technical details

Rated load capacity	6.500 kg 7.500 kg
Lifting height max.	2.165 mm
Drive-through width	2.800 mm
Overall width	3.920 mm
Support arms parts	3
Motor power	3 kW
Lifting/Lowering time	approx. 50 s
Power supply voltage	3x 400V / C16A
Concrete strength	min. C25/30 6.000x4.000x 250 mm 300 mm

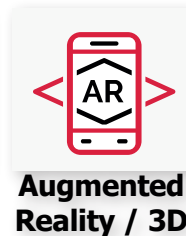
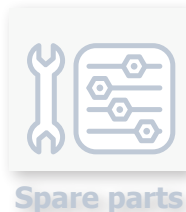
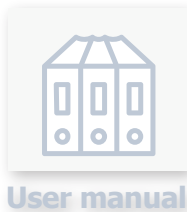
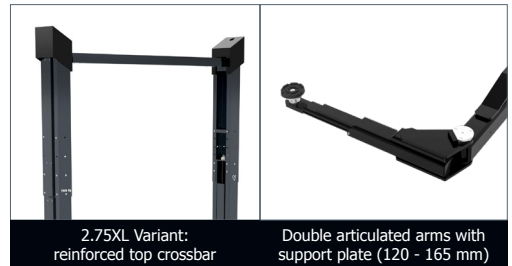
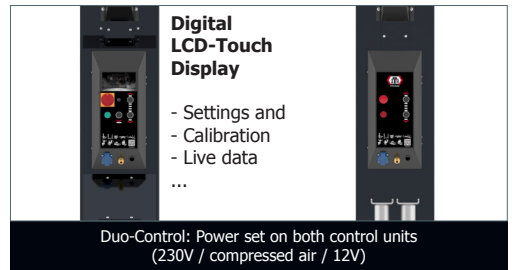

PDF Product flyer

ATH Matrix Lift 2.65

Item number

622225

PDF Product flyer

ATH Matrix Lift 2.75XL

Item number

622224

ATH Matrix Lift 2.65 | 2.75XL

Item number: 622225 | 622224
ATH Matrix Lift: 2.65 | 2.75XL

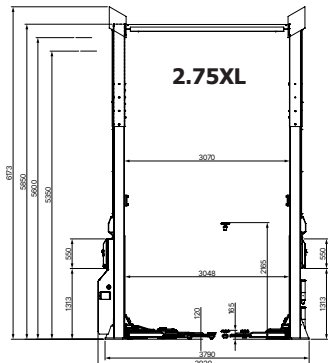
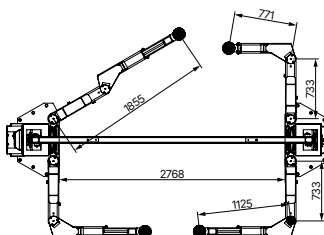
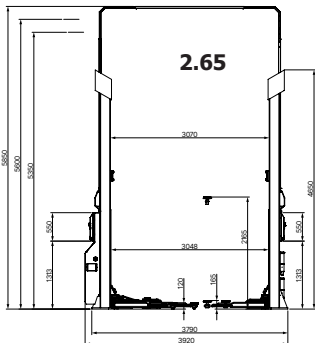

ATH Pure Lift 2.40 | 2.40A

- High quality and robust electro-hydraulic 2-post lift
- Very low drive-over plate (height = approx. 20 mm) for comfortable work
- Multifunctional mounting through telescopic support arms
- Double telescopic support plate (90-180 mm) with anti-twist protection
- Automatic and self-centering arm lock
- Powder-coated lifting platform in modern anthracite gray
- **2.40: Mechanical safety rates with manual lowering valve (central one-hand release)**
- **2.40A: Automatic safety rates with automatic lowering valve**

Technical details

Rated load capacity	4.000 kg
Lifting height max.	1.900 mm
Drive-through width	2.600 mm
Overall width	3.455 mm
Support arms parts	3 2
Motor power	2,2 kW
Lifting/Lowering time	approx. 45s / 35s
Power supply voltage	230V / C16A resp. 3x 400V / C16A
Concrete strength	min. C20/25 4.000x2.000x 200 mm



Very low drive-over plate (height = approx. 20 mm)

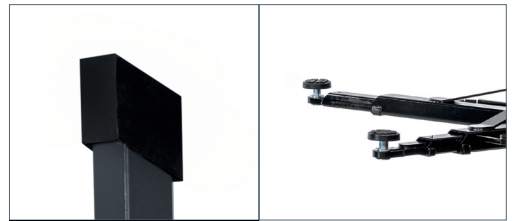

Column cover
(optional HSA1252)

Telescopic carrying arms
rear 2-piece, front 3-piece



Accessories



User manual

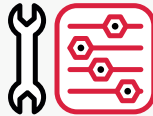

Spare parts



**Augmented
Reality / 3D**



Service

PDF Product flyer

Item number

ATH Pure Lift 2.40 230V

622162

ATH Pure Lift 2.40 400V

622161

PDF Product flyer

Item number

ATH Pure Lift 2.40A 230V

622401

ATH Pure Lift 2.40A 400V

622400



ATH Pure Lift 2.40 | 2.40A

Item number: 622162 2.40 230V | 622161 2.40 400V
622401 2.40A 230V | 622400 2.40A 400V

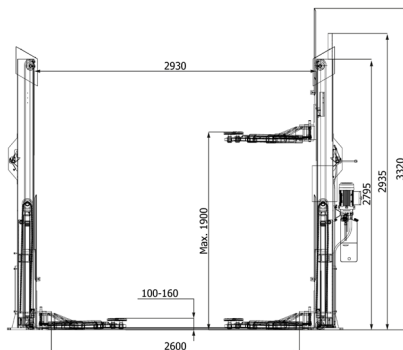
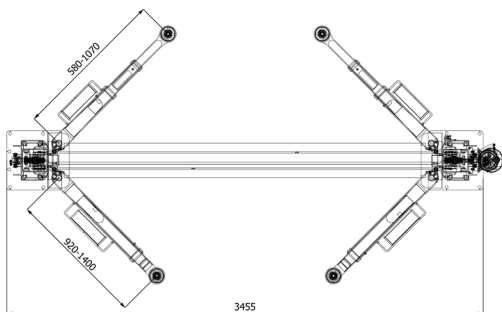

ATH Single Lift 35M

- Electro-hydraulic 1-post lift with quick lift unit and load-dependent lowering function
- Central control unit with energy set (230V / 12V)
- Mobile use with the help of the high-quality wheel set, no attachment to the floor
- Safety Control: Electromagnetic safety locks that automatically unlock with lifting and lowering
- Safety Lock: ability to lock the load on to the safety mechanism
- Multifunctional mounting via the pull-out crossbeam, double telescopic support arms and support plates
Including support plate extension 4 x 80mm

Technical details

Rated load capacity	3.500 kg
Lifting height min. - max.	115–1.853 mm
Overall height	2.700 mm
Overall width	1.356–2.215 mm
Support arms parts	3
Motor power	3kW
Lifting/Lowering time	approx. 45s
Power supply voltage	3x 400V / C16A
Concrete strength	min. C20/25 Thickness: 200mm



Double telescopic support arms



Support plate
(115 - 155 mm)

High quality drive set
Power set on the control unit



Accessories



User manual

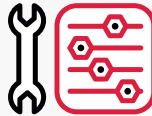

Spare parts



**Augmented
Reality / 3D**



Service

PDF Product flyer

Item number

ATH Single Lift 35M

612013

ATH Single Lift 35M

Item number: 612013

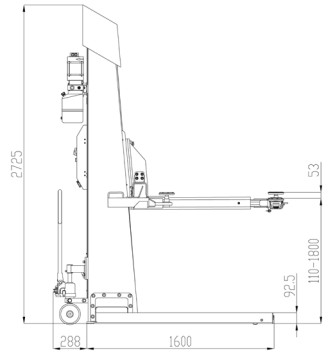
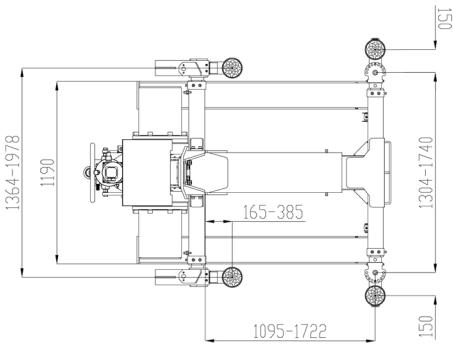

ATH Single Lift 25M

- Electro-hydraulic 1-post lift with quick lift unit and load-dependent lowering function
- Central control unit with energy set (230V / 12V)
- Mobile & stationary use with the help of the high-quality wheels or attachment to the floor
- Safety Control: Electromagnetic safety catches that automatically unlock when lifting and lowering
- Safety Lock: ability to lock the load on to the safety mechanism
- Multifunctional mounting via double telescopic support arms and support plates

Technical details

Video



Rated load capacity	2.500 kg
Lifting height min. - max.	115–1.870 mm
Overall height	2.910 mm
Overall width	1.550–2.175 mm
Support arms parts	2
Motor power	3kW
Lifting/Lowering time	approx. 40s
Power supply voltage	3x 400V / C16A
Concrete strength	min. C20/25 Thickness: 200mm

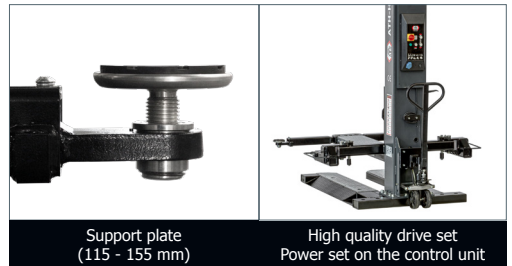

Accessories



User manual

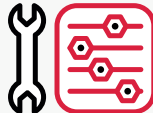

Spare parts



**Augmented
Reality / 3D**



Service

PDF Product flyer

Item number

ATH Single Lift 25M

612010

ATH Single Lift 25M

Item number: 612010

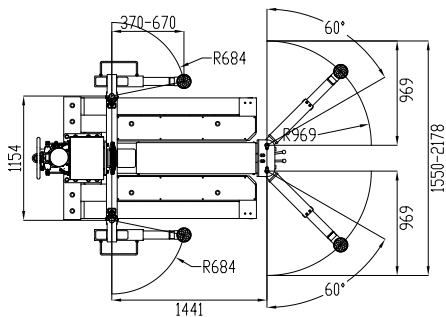
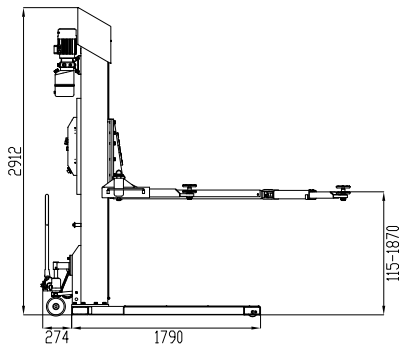

ATH Single Lift 12PL

- Electro-hydraulic 1-post lift with quick lift unit and load-dependent lowering function
- Central control unit with energy set (230V / compressed air / 12V)
- Stationary use, with reinforced column and rail construction
- Safety Control: Electromagnetic release of the safety locks automatically with lifting and lowering
- Safety Lock: ability to lock the load on to the safety mechanism
- Multifunctional mounting via sliding, extra long rails and wheel forks (optional)
- Ideally suited for repairing quads, lawn mowers and small tractors

Technical details

Rated load capacity	1.200 kg
Lifting height min. - max.	1.930 mm
Overall height	3.138 mm
Overall width	1.900 mm
Overall length	2.937 mm
Motor power	3kW
Lifting/Lowering time	approx. 20s
Power supply voltage	3x 400V / C16A
Concrete strength	min. C25/30 2.500x200x 200mm

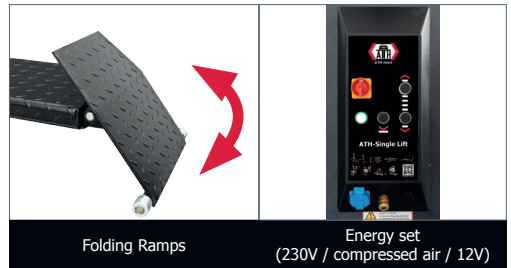
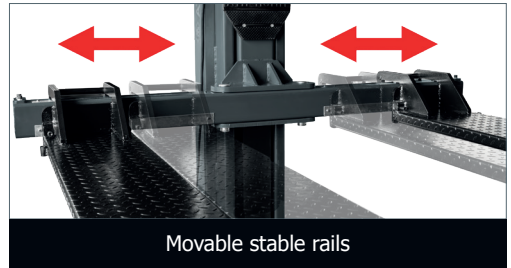

Accessories



User manual

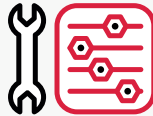

Spare parts



Augmented Reality / 3D



Service

PDF Product flyer

Item number

ATH Single Lift 12PL

612016

ATH Single Lift 12PL

Item number: 612016

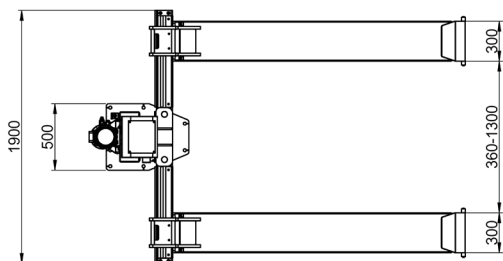

360mm with optional accessories (wheel clamps)

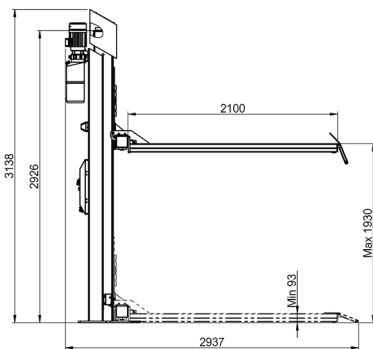

ATH Four Lift 55HP

- Electro-hydraulic 4-post lift with quick lift unit and load-dependent lowering function
- Central operating unit, including unit cover
- Level running rail with integrated wheel-free jack (load capacity 3.5t) optional wheel alignment kit
- Precisely levelable notch and rail system
- Safety Control: Electropneumatic safety locks that automatically unlock with lifting and lowering
- Safety Lock: ability to lock the load on to the safety mechanism
- Multifunctional mounting via continuously adjustable rails
- Perfect platform protection made of special polymer and double powder coating

Technical details

Rated load capacity	5.500 kg
Lifting height max.	1.960 mm
Drive-on-height	210 mm
Total platform length	5.600 mm
Total platform width	650 mm
Motor power	4 kW
Lifting/Lowering time	approx. 45 s
Power supply voltage	3x 400V / C16A
Concrete strength	min. C20/25 7.400 x 3.900 x 200 mm

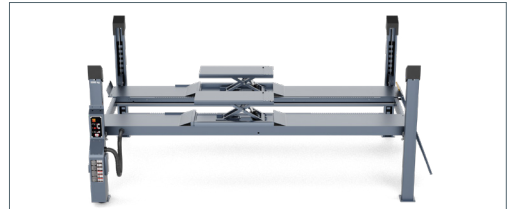

Wheel-free jack (load capacity 3.5 t) without wheel alignment kit

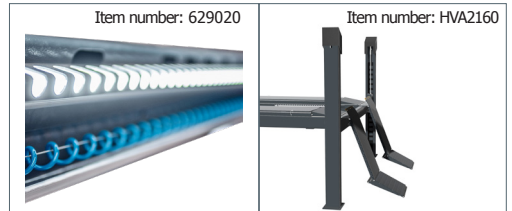

Optional
24V LED lighting

Optional extensions for
Drive-on ramps (640mm)



Accessories



User manual



Spare parts



**Augmented
Reality / 3D**



Service

PDF Product flyer

Item number

ATH Four Lift 55HP

650021

ATH Four Lift 55HP

Item number: 650021

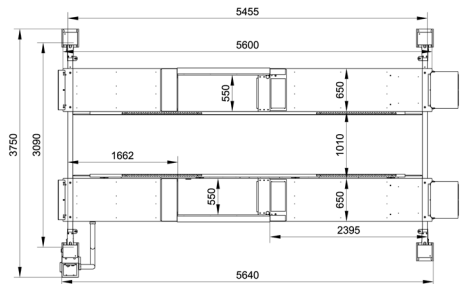
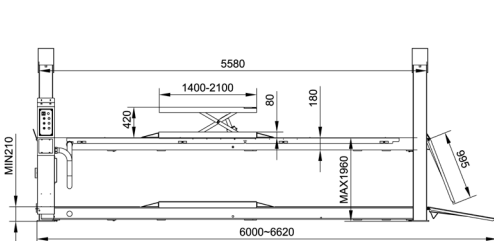
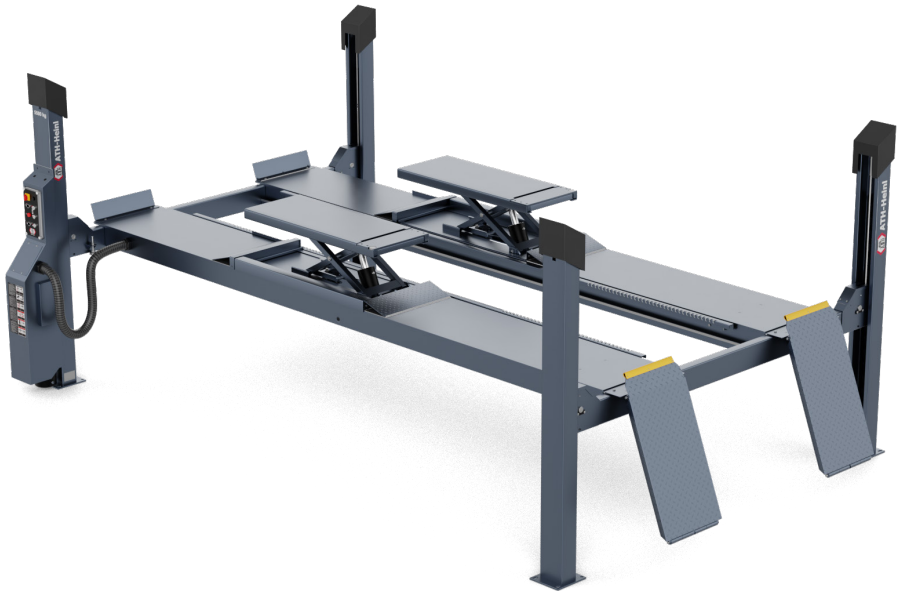

ATH Four Lift 55HAP

- Electro-hydraulic 4-post lift with quick lift unit and load-dependent lowering function
- Central operating unit, including unit cover
- Level running rail with integrated wheel-free jack (load capacity 3.5t) and wheel alignment kit
- Precisely levelable notch and rail system
- Safety Control: Electropneumatic safety locks that automatically unlock with lifting and lowering
- Safety Lock: ability to lock the load on to the safety mechanism
- Multifunctional mounting via continuously adjustable rails
- Perfect platform protection made of special polymer and double powder coating

Technical details

Rated load capacity	5.500 kg
Lifting height max.	2.045mm
Drive-on-height	275 mm
Total platform length	5.600 mm
Total platform width	650 mm
Motor power	4kW
Lifting/Lowering time	approx. 45 s
Power supply voltage	3x 400V / C16A
Concrete strength	min. C20/25 7.400x3.900x 200 mm

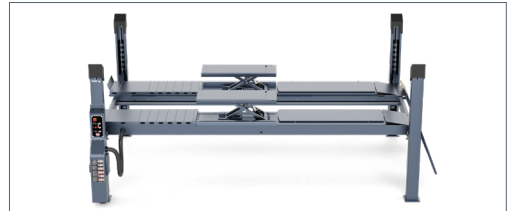

Wheel-free jack (load capacity 3.5 t) **with** wheel alignment kit

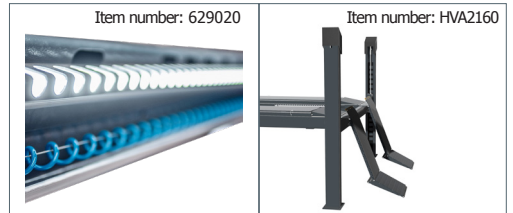

Optional
24V LED lighting

Optional extensions for
Drive-on ramps (640mm)



Accessories



User manual



Spare parts



**Augmented
Reality / 3D**



Service

PDF Product flyer

Item number

ATH Four Lift 55HAP

650022

ATH Four Lift 55HAP

Item number: 650022

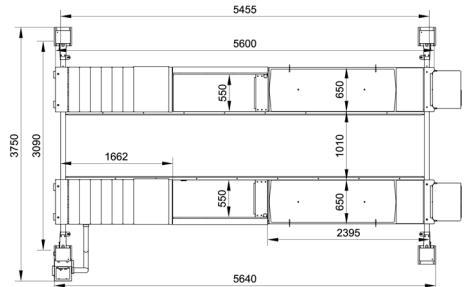
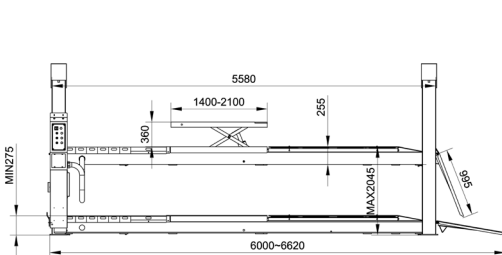
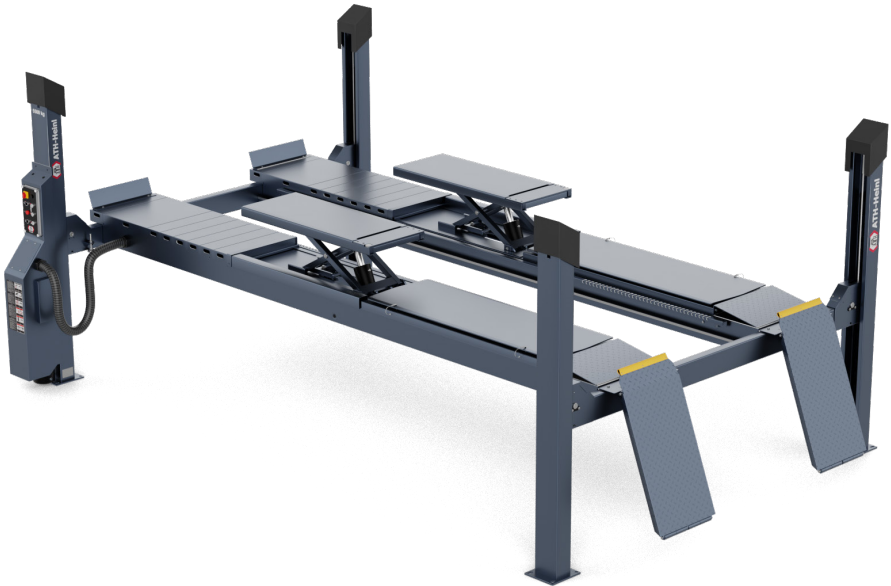

ATH Four Lift 55AP | 55P

- Electro-hydraulic 4-post lift with quick lift unit and load-dependent lowering function
- Central operating unit, including unit cover
- ATH Four Lift 55AP: Level running rail with integrated wheel alignment kit
- ATH Four Lift 55P: level running rail, optional wheel alignment kit
- Precisely levelable notch and rail system
- Safety Control: Electropneumatic safety locks that automatically unlock with lifting and lowering
- Safety Lock: ability to lock the load on to the safety mechanism
- Multifunctional mounting via continuously adjustable rails
- Perfect platform protection made of special polymer and double powder coating

Technical details

Rated load capacity	5.500 kg
Lifting height max.	2.045mm
Drive-on-height	275 mm
Total platform length	5.600 mm
Total platform width	650 mm
Motor power	4kW
Lifting/Lowering time	approx. 45s
Power supply voltage	3x 400V / C16A
Concrete strength	min. C20/25 7.400x3.900x 200mm

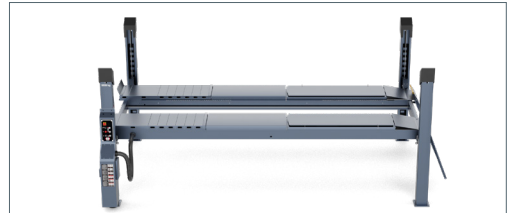

ATH Four Lift 55AP
Level guide rail **with** axis measurement kit

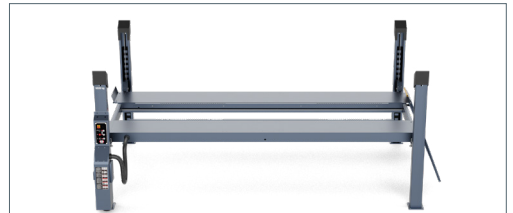

ATH Four Lift 55P
Level guide rail **without** axis measurement kit



Accessories



User manual



Spare parts



Augmented Reality / 3D



Service

PDF Product flyer

Item number

ATH Four Lift 55P

650023

PDF Product flyer

Item number

ATH Four Lift 55AP

650024

ATH Four Lift 55AP

Item number: 650023 55P | 650024 55AP

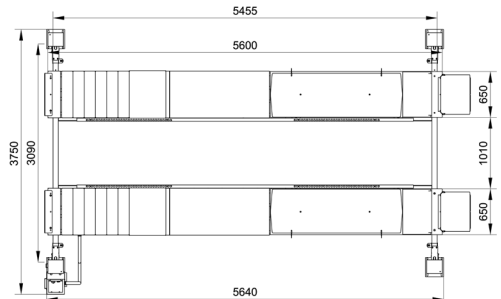
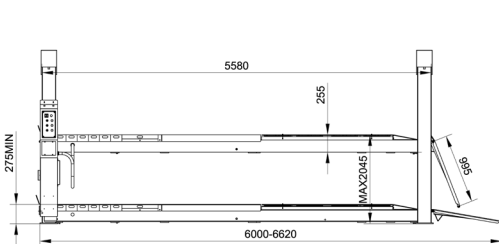
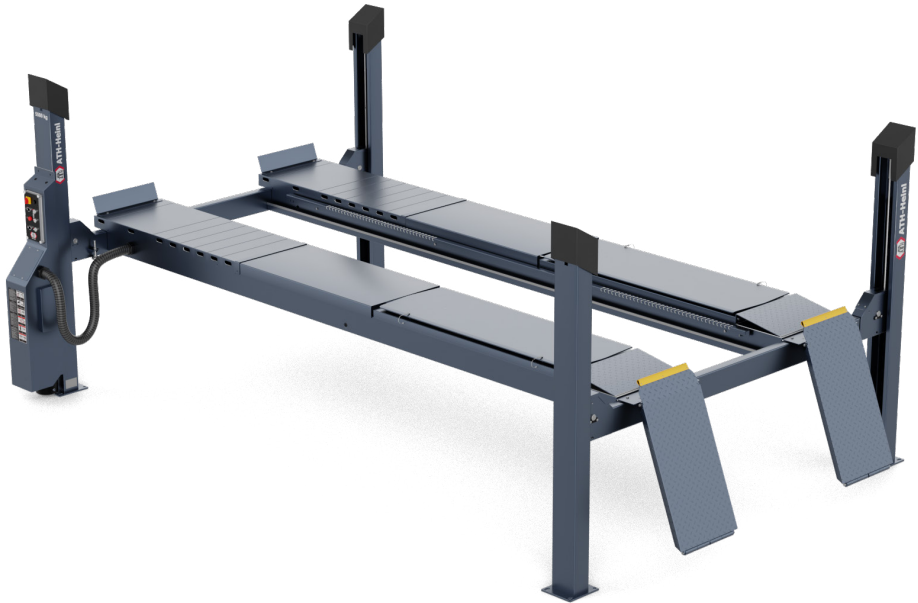

ATH Four Lift 46 | 64 P | AP

- Electro-hydraulic 4-post lift with quick lift unit and load-dependent lowering function
- Central operating unit, including unit cover
- ATH Four Lift 46 / 64AP: Level running rail with integrated wheel alignment kit
- ATH Four Lift 46 / 64P: level runway, optional wheel alignment kit
- Precisely levelable notch and rail system
- Safety Control: Electropneumatic safety locks that automatically unlock with lifting and lowering
- Safety Lock: ability to lock the load on to the safety mechanism
- Multifunctional mounting via continuously adjustable rails
- Perfect platform protection made of special polymer and double powder coating

Technical details

Rated load capacity	4.600 kg 6.400 kg
Lifting height max.	1.850 mm
Drive-on-height	235 mm
Total platform length	5.310 mm
Total platform width	512 mm
Motor power	4,0 kW
Lifting/Lowering time	approx. 48 s
Power supply voltage	3x 400V / C16A
Concrete strength	min. C20/25 7.400x3.900x 200 mm

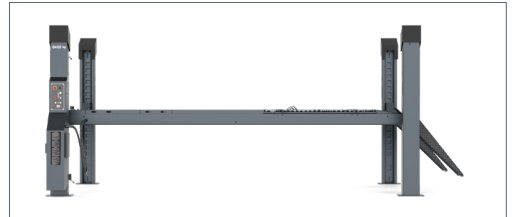

ATH Four Lift 46AP / 64AP
Level guide rail **with** axis measurement kit

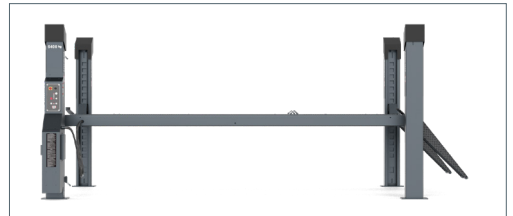

ATH Four Lift 46P / 64P
Level guide rail without axis measurement kit



Accessories



User manual

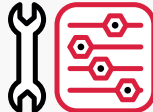

Spare parts



Augmented Reality / 3D



Service

PDF Product flyer

Item number

ATH Four Lift 46P

650027

ATH Four Lift 64P

650025

PDF Product flyer

Item number

ATH Four Lift 46AP

650028

ATH Four Lift 64AP

650026



ATH Four Lift 46 | 64 P | AP

Item number: 650027 46P | 650028 46AP
650025 64P | 650026 64AP

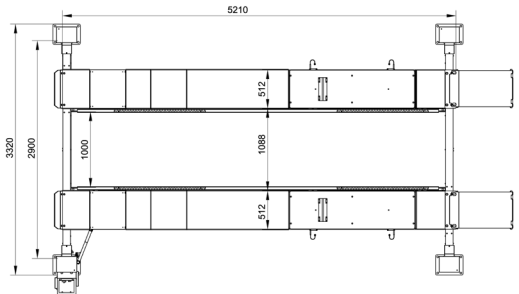
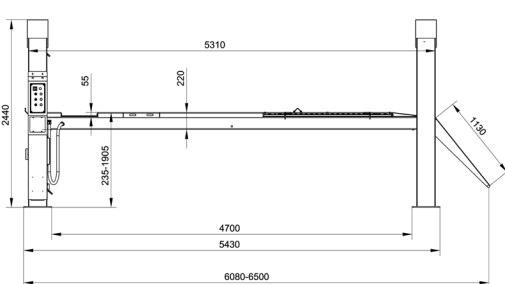

ATH Cross Lift 35 OG | OGA | UGA

- High quality and robust scissor lift with hydraulic drive, almost maintenance-free
- Powerful hydraulic unit with load-dependent lowering speed controller
- With wheel-free jack (load capacity: 3.5 t, lifting height: 430 mm), optional wheel alignment kit with cut outs for swivel plates at the front and mechanically lockable swing plates at the rear (incl. at ATH Cross Lift 35 OGA / UGA)
- Pneumatic unlocking of the safety locks, CE-Stop and lowering acoustic signal
- Emergency lowering system for lowering in the event of a power failure, safety synchronization monitoring via light barrier
- Ideally suited for inspection, repair and test stations for driver assistance systems, optionally for wheel alignment

Technical details

Rated load capacity	3.500 kg
Lifting height max.	1.830 mm
Drive-on-height	170 mm
Total platform length	4.400 mm
Total platform width	620 mm
Motor power	2,6 kW
Lifting/Lowering time	approx. 60 s
Power supply voltage	3x 400V / C16A
Concrete strength	min. C20/25 6.100x3.000x 200 mm



ATH Cross Lift 35 OGA: above ground, integrated wheel-free lift, active platform and wheel alignment kit included



ATH Cross Lift 35 UGA: underfloor, integrated wheel-free lift, active platform and wheel alignment kit included



Accessories



User manual

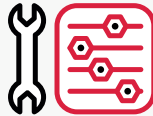

Spare parts



Augmented Reality / 3D



Service

PDF Product flyer

Item number

ATH Cross Lift 35 OG

631014

ATH Cross Lift 35 OGA

631020

PDF Product flyer

Item number

ATH Cross Lift 35 UGA

631021

ATH Cross Lift 35

Item number: 631014 35 OG | 631020 35 OGA | 631021 35 UGA

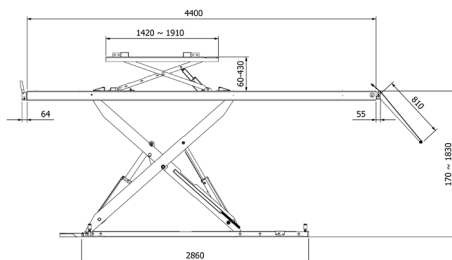

ATH Cross Lift 40 | Cross Lift 50

- High quality and robust scissor lift with hydraulic drive, almost maintenance-free
- Powerful hydraulic unit with load-dependent lowering valve
- Suitable for floor-level installation and installation on the floor with the optional on ground kit
- With recesses for rotating plates at the front, mechanically lockable oscillating plates at the rear, Wheel-free jack (load capacity: 4 t, lifting height: 450 mm), side rails for the optional axle-free jack, removable cross connections, including metal protection bar and switch for the optional 24V LED lighting
- Emergency lowering system for lowering in the event of a power failure, synchronization monitoring via safety light barrier
- Ideally suited for inspection, wheel alignment, repairs and test stations for headlamp and driver assistance systems

Technical details	Video 
Rated load capacity	4.000 kg 5.000 kg
Lifting height max.	2.160 mm
Installation depth	295 mm
Total platform length	4.230 5.000 mm
Total platform width	600 mm
Motor power	3,5 kW
Lifting/Lowering time	ca. 70 s
Power supply voltage	3x 400V / C16A
Concrete strength	min. C20/25 5.500x3.000x 200 mm

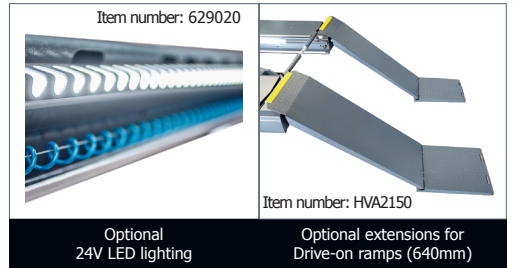

Accessories



User manual



Spare parts

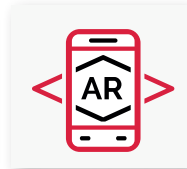

Augmented Reality / 3D



Service

PDF Product flyer	Item number
ATH Cross Lift 40 UGA	631025
ATH Cross Lift 40 OGA	631026

PDF Product flyer	Item number
ATH Cross Lift 50 UGA	631011
ATH Cross Lift 50 OGA	631022

ATH Cross Lift 40 | 50

Item number: 631025 Cross 40 UGA | 631026 Cross 40 OGA
631011 Cross 50 UGA | 631022 Cross 50 OGA

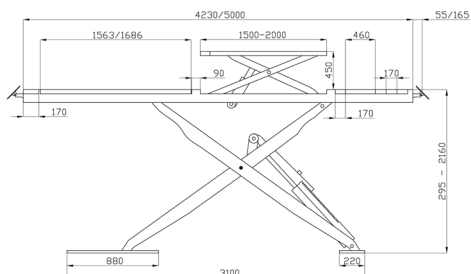
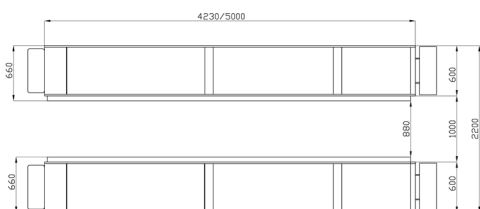

ATH Cross Lift 40 | 50 Plus UGA | OGA

- High quality and robust scissor lift with hydraulic drive, almost maintenance-free
- Powerful hydraulic unit with load-dependent lowering valve
- Suitable for floor-level installation and installation on the floor with the optional on ground kit
- With recesses for rotating plates at the front, pneumatically lockable oscillating plates at the rear, platform extension including joint play tester, wheel-free jack (load capacity: 4 t, lifting height: 450 mm), side rails for the optional axle jack, removable cross connections, 24V LED lighting including metal protection bar and switch
- Emergency lowering system for lowering in the event of a power failure, synchronization monitoring via safety light barrier
- Ideally suited for inspection, wheel alignment, repairs and test stations for headlamp and driver assistance systems

Technical details

Video



Rated load capacity	4.000 kg 5.000 kg
Lifting height max.	2.160 mm
Installation depth	295 mm
Total platform length	4.830 5.600 mm
Total platform width	600 mm
Motor power	3,5 kW
Lifting/Lowering time	approx. 70 s
Power supply voltage	3x 400V / C16A
Concrete strength	min. C20/25 6.100x3.000x 200 mm



ATH Cross Lift 40 / 50 Plus OGA including above-ground kit

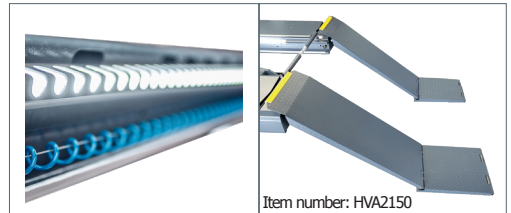

Item number: HVA2150

Included
24V LED lighting

Optional extensions for
drive-on ramps (640mm)



Accessories



User manual

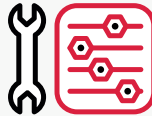

Spare parts



**Augmented
Reality / 3D**



Service

PDF Product flyer

Item number

ATH Cross Lift 40 Plus UGA 631027

ATH Cross Lift 50 Plus UGA 631016

PDF Product flyer

Item number

ATH Cross Lift 40 Plus OGA 631028

ATH Cross Lift 50 Plus OGA 631024

ATH Cross Lift 40 | 50 Plus

Item number: 631027 40 Plus UGA | 631028 40 Plus OGA
631016 50 Plus UGA | 631024 50 Plus OGA

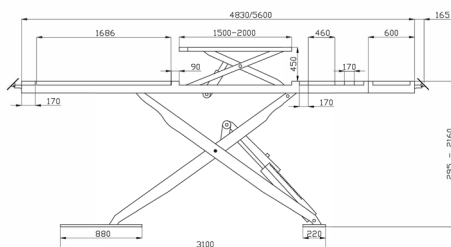
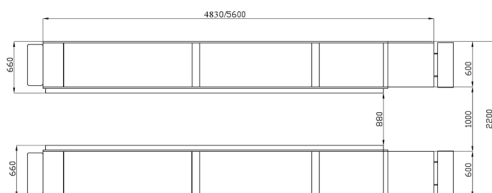

ATH Frame Lift 30FZ | 30FZ UG

- High-quality and robust double scissor lift with hydraulic drive, almost maintenance-free
- Powerful hydraulic unit with load-dependent lowering valve
- Very low drive-over height of only approx. 105 mm
- Suitable for installation and use on the floor and optional floor-level installation (in ground kit)
- Synchronization control via double master and slave systems, safety light barriers and double hydraulic lines
- Full lifting power from the lowest point due to mechanical swivel system
- Emergency lowering system for lowering in the event of a power failure, CE-Stop and acoustic lowering signal
- Ideally suited for paint and body shops, repairs, brake and tire services

Technical details

Video



Rated load capacity	3.000 kg
Lifting height max.	1.900 mm
Drive-on-height	105 mm
Total platform length	1.495–2.030 mm
Total platform width	600 mm
Motor power	2,6 kW
Lifting/Lowering time	approx. 50 s
Power supply voltage	3x 400V / C16A
Concrete strength	min. C20/25 2.500 x 2.500 x 180 mm



Partial galvanizing incl. powder coating



Item number: HUK2200

Underfloor kit included
at Frame Lift 30FZ UG



Lockable
Access flaps



Accessories



User manual

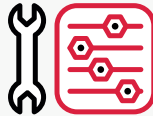

Spare parts



**Augmented
Reality / 3D**



Service

PDF Product flyer

Item number

ATH Frame Lift 30FZ

630311

PDF Product flyer

Item number

ATH Frame Lift 30FZ UG

630322



ATH Frame Lift 30FZ | UG

Item number: 630311 30FZ | 630322 30FZ UG

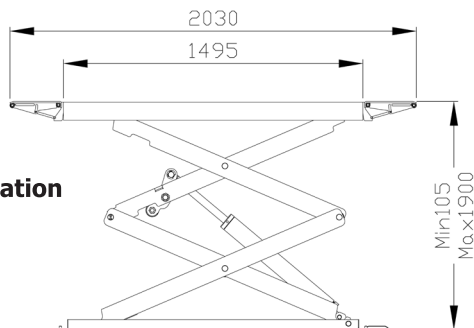
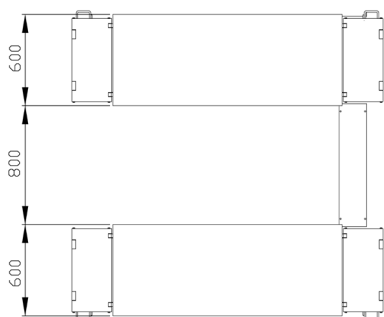

ATH Frame Lift 35FZ | 35FZ UG

- High-quality and robust double scissor lift with hydraulic drive, almost maintenance-free
- Powerful hydraulic unit with load-dependent lowering valve
- Very low drive-over height of only approx. 105 mm
- Suitable for installation and use on the floor and optional floor-level installation (in ground kit)
- Synchronization control via double master and slave systems, light barriers and double hydraulic lines
- Full lifting power from the lowest point due to mechanical swivel system
- Emergency lowering system for lowering in the event of a power failure, CE-Stop and acoustic lowering signal
- Ideally suited for paint and body shops, repairs, brake and tire services

Technical details	Video 
Rated load capacity	3.500 kg
Lifting height max.	1.900 mm
Drive-on-height	105 mm
Total platform length	1.547–2.270 mm
Total platform width	625 mm
Motor power	2,6 kW
Lifting/Lowering time	approx. 50 s
Power supply voltage	3x 400V / C16A
Concrete strength	min. C20/25 2.500 x 2.500 x 180 mm

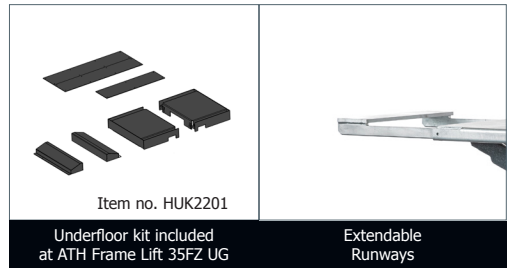
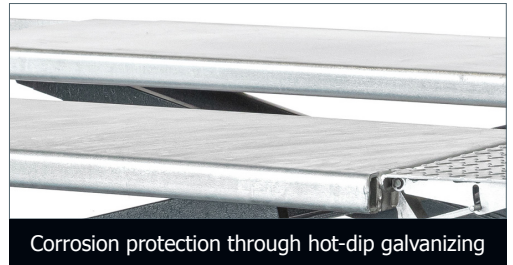

Accessories

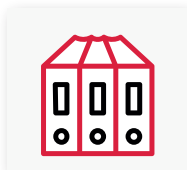

User manual



Spare parts

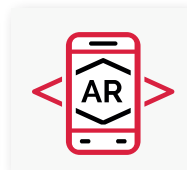

Augmented Reality / 3D



Service

PDF Product flyer

Item number

ATH Frame Lift 35FZ

630312

PDF Product flyer

Item number

ATH Frame Lift 35FZ UG

630324

ATH Frame Lift 35FZ | UG

Item number: 630312 35FZ | 630324 35FZ UG

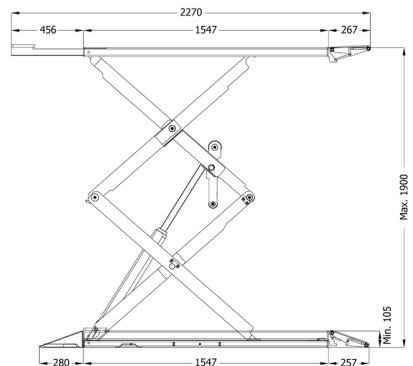
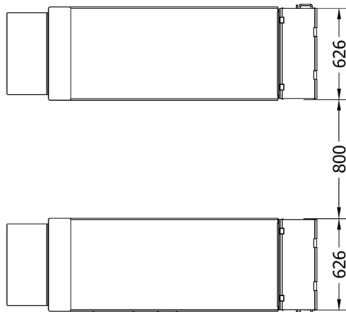

ATH Flex Lift 30

- High-quality and robust short-stroke lift with hydraulic drive, almost maintenance-free
- Powerful hydraulic unit (230V / C16A)
- Very low drive-over height of only approx. 105 mm
- No electrical limit switches, protective hose over the hydraulic lines
- Mechanical synchronization through cross connection and double hydraulic lines
- Full lifting power from the lowest point
- Emergency lowering system for lowering in the event of a power failure
- Ideally suited for paint and body shops, repairs, brake and tire services

Technical details

Video

Rated load capacity	3.000 kg
Lifting height max.	960 mm
Drive-on-height	105 mm
Total platform length	1.450–2.040 mm
Total platform width	530 mm
Motor power	2,2 kW
Lifting/Lowering time	approx. 20 s
Power supply voltage	230V / C16A
Concrete strength	min. C20/25 Thickness: 200 mm



Incl. kit for mobile use



Double hydraulic lowering lock
(no safety catch or compressed air required)



Accessories



User manual



Spare parts



Augmented Reality / 3D



Service

PDF Product flyer

Item number

ATH Flex Lift 30

680008

ATH Flex Lift 30

Item number: 680008

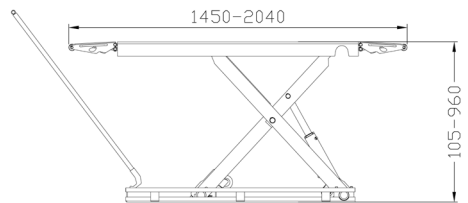
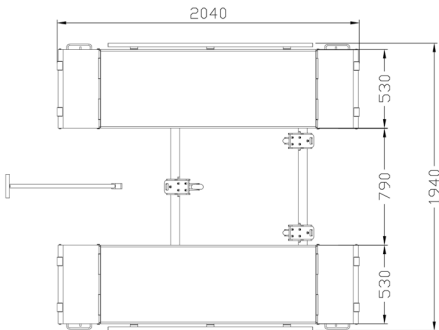

ATH Flex Lift 30Z

- High-quality and robust short-stroke lift with hydraulic drive, almost maintenance-free
- Powerful hydraulic unit (230V / C16A)
- Very low drive-over height of only approx. 105 mm
- No electrical limit switches, protective hose over the hydraulic lines
- Mechanical synchronization through cross connection and double hydraulic lines
- Full lifting power from the lowest point
- Emergency lowering system for lowering in the event of a power failure
- Ideally suited for paint and body shops, repairs, brake and tire services

Technical details

Video

Rated load capacity	3.000 kg
Lifting height max.	960 mm
Drive-on-height	105 mm
Total platform length	1.450–2.040 mm
Total platform width	530 mm
Motor power	2,2 kW
Lifting/Lowering time	approx. 20 s
Power supply voltage	230V / C16A
Concrete strength	min. C20/25 Thickness: 200 mm



Incl. kit for mobile use
Corrosion protection through hot-dip galvanizing



Double hydraulic lowering lock
(no safety catch or compressed air required)



Accessories



User manual

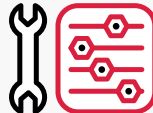

Spare parts



Augmented Reality / 3D



Service

PDF Product flyer

Item number

ATH Flex Lift 30Z

680008-FZ

ATH Flex Lift 30Z

Item number: 680008-FZ

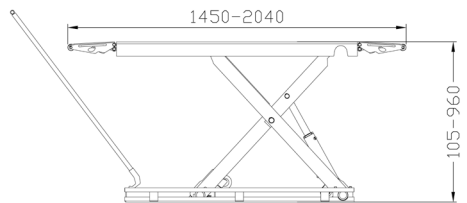
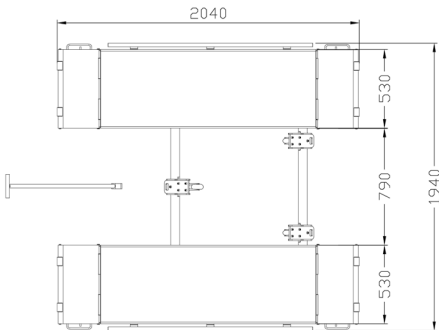

ATH Bike Lift 7 | 7F | 7Q | 7QF

- High-quality and robust motorcycle lift with hydraulic drive, almost maintenance-free
- Powerful hydraulic unit (230V / C16A)
- Removable plate for free work on the rear and front tires
- Protective hose over the hydraulic lines
- Tripping hazards avoided with access ramp automatic retracting when lifting
- Fixed aluminium plate specially designed to hold mini motorcycle stands
- Emergency lowering system for lowering in the event of a power failure
- Pneumatic wheel holder included for ATH Bike Lift 7F and 7QF
- Optional mini motorcycle stand: Item no.: 670025

Technical details

Rated load capacity	700 kg
Lifting height max.	1.200 mm
Drive-on-height	80 mm
Total platform length	2.300 mm
Total platform width	785 mm/1.260 mm
Motor power	1 kW
Lifting/Lowering time	approx. 15 s
Power supply voltage	230V / C16A
Concrete strength	min. C20/25 2.500x1.000x 100mm

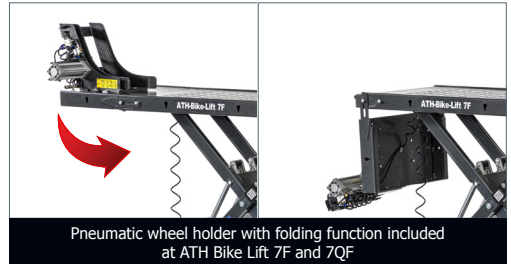

Accessories



User manual

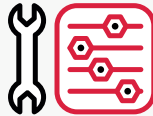

Spare parts



Augmented Reality / 3D



Service

PDF Product flyer

Item number

ATH Bike Lift 7

670041

ATH Bike Lift 7F

670042

PDF Product flyer

Item number

ATH Bike Lift 7Q

670043

ATH Bike Lift 7QF

670044

ATH Bike Lift 7 | 7F | 7Q | 7QF

Item number: 670041 Bike Lift 7 | 670042 Bike Lift 7F
670043 Bike Lift 7Q | 670044 Bike Lift 7QF

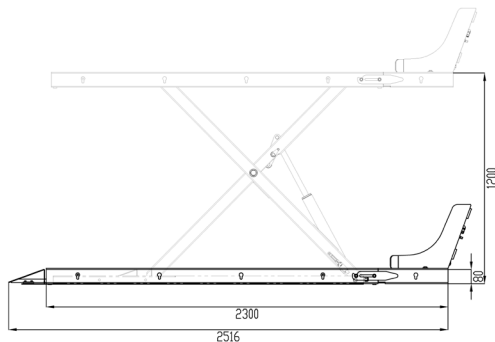
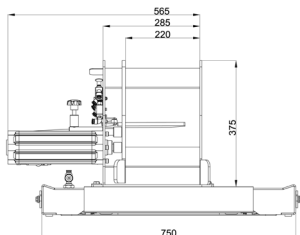

ATH RG5.5 WB

- Electro-hydraulic wheel gripper system with battery operation and wireless control
- Control unit including unit cover on each column for flexible use
- Master unit controls all operating information on each column and an extension up to 16 columns
- Integrated quick charger per column, enables charging during use.
- Mobile kit and forklift attachment on the columns enable a faster change of position
- Safety Control: hydraulic shut-off valve, electronic synchronization monitoring and electromagnetic safety locks
- Safety Lock: ability to lock the load on to the safety mechanism
- Multifunctional mounting via variable wheel fork with individual setting options

Technical details

Load capacity	5.500 kg
Lifting height	1.750 mm
Column height	2.750 mm
Column width	1.110mm
Motor power	2,2 kW
Lifting/lowering time	80s / 70s
Operating voltage	DC 24V
Column communication	wireless
Concrete strength	min. C20/25 Thickness: 200mm



Variable positioning with hand-hydraulic undercarriage; can be easily extended to 6-post wheel gripper system

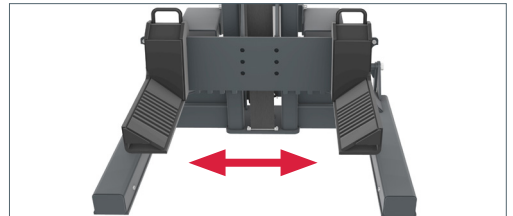

Adjustable pickup 166 mm to 550 mm



Accessories



User manual



Spare parts



Augmented Reality / 3D



Service

PDF Product flyer Item number

ATH RG5.5 2 columns WB 710039

ATH RG5.5 6 columns WB 710037

Product name Item number

ATH RG5.5 4 columns WB 710036

ATH RG5.5 WB

Item number: 710039 (RG5.5-2 WB) | 710036 (RG5.5-4 WB)
710037 (RG5.5-6 WB)



Example image: 4 of maximum 16 columns

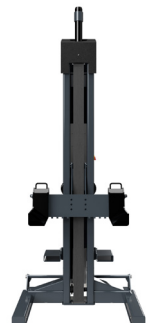
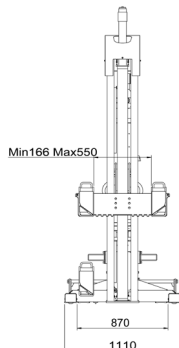
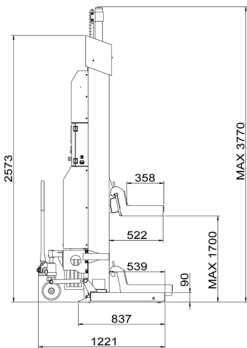

ATH RG8.5 WB

- Electro-hydraulic wheel gripper system with battery operation and wireless control
- Control unit including unit cover on each column for flexible use
- Master unit controls all columns and can control up to 16 units
- Integrated quick charger per column, enables charging during use
- Mobile kit and forklift attachment on the column enable a faster change of position
- Safety Control: hydraulic shut-off valve, electronic synchronization monitoring and electromagnetic safety locks
- Safety Lock: ability to lock the load on to the safety mechanism
- Multifunctional mounting via variable wheel fork with individual setting options

Technical details

Load capacity	8.500 kg
Lifting height	1.700 mm
Column height	2.650 mm
Column width	1.145 mm
Motor power	2,2 kW
Lifting/lowering time	120s / 70s
Operating voltage	DC 24V
Column communication	wireless
Concrete strength	min. C20/25 Thickness: 200mm



Variable positioning with hand-hydraulic trolley

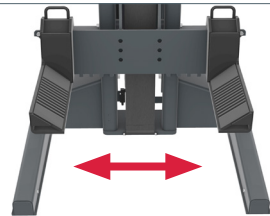

Adjustable pickup 240 mm to 625 mm



Accessories



User manual

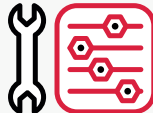

Spare parts



Augmented Reality / 3D



Service

PDF Product flyer

Item number

ATH RG8.5 2 columns WB 710040

ATH RG8.5 6 columns WB 710035

Product name

Item number

ATH RG8.5 4 columns WB 710034

ATH RG8.5 WB

Item number: 710040 (RG8.5-2 WB) | 710034 (RG8.5-4 WB)
710035 (RG8.5-6 WB)



Example image: 6 of maximum 16 columns

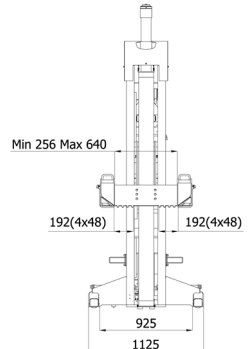
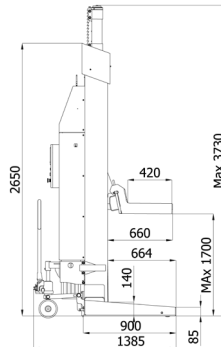

ATH M72Z Plus



- Rear swivel with pneumatic mounting head clamping including automatic vertical and horizontal rim removal
- Control via ergonomically arranged foot pedals
- Including pneumatic controlled auxiliary assembly arm for effortless and damage-free assembly of low-profile, UHP and run-flat tires
- Height-adjustable center hole mounting with use of a clamping flange and quick-release nut
- Lateral extractor with double-acting aluminium cylinder and anti-jamming system
- Including wheel lift, quick release tool, pneumatic assembly tool and WDK kit

Technical details	Video
Rim diameter max.	12–26"
Rim width	4–13"
Max. wheel diameter	1.050 mm
Compressed air connection	10bar
Bead breaking range	83–350 mm
Bead breaker force	2.500 kg
Mounting speeds	6 and 12 rpm
Driving power	0,75 / 0,90 kW
Power supply voltage	3x 400V / C16A
Noise level	70dB(A)

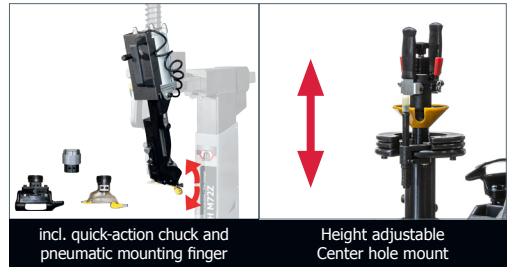

Accessories

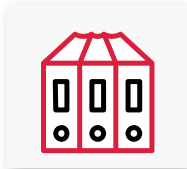

User manual



Spare parts

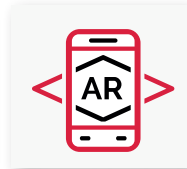

Augmented Reality / 3D



Service

PDF Product flyer	Item number
ATH M72Z Plus	151038



ATH M72Z Plus

Item number: 151038

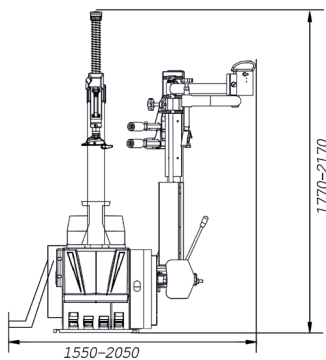
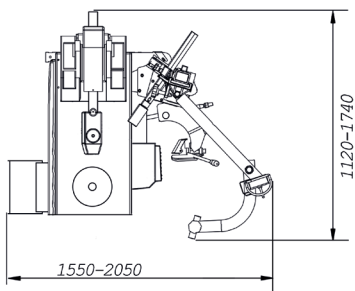

ATH M72 + A34 Plus WDK

- Rear swivel with pneumatic mounting head clamping including automatic vertical and horizontal Rim removal
- Control via ergonomically arranged foot pedals
- Including pneumatic controlled auxiliary assembly arm for effortless and damage-free assembly of low-profile, UHP and run-flat tires
- Self-centering, pre-adjustable 4-jaw system, 3-fold quick adjustment
- Lateral extractor with double-acting aluminium cylinder and anti-jamming system
- Including quick-release tool, pneumatic assembly finger and WDK kit
- Ideally suited for car tires, with optional accessories also for motorcycle bikes

Technical details

Video



Clamping range inner / outer	11–30" / 9–26"
Rim width	4–13"
Max. wheel diameter	1.050 mm
Compressed air connection	10 bar
Bead breaking range	83–350 mm
Bead breaker force	2.500 kg
Mounting speeds	6 and 12 rpm
Driving power	0,75 / 0,90 kW
Power supply voltage	3x 400V / C16A
Noise level	70 dB(A)



Scope of delivery

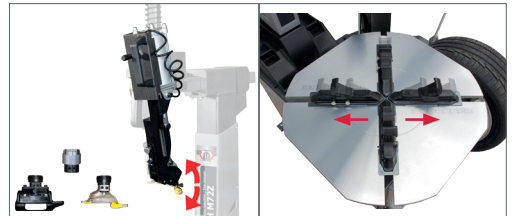

incl. quick-action chuck and pneumatic mounting finger

Clamping range 3-way adjustable



Accessories



User manual

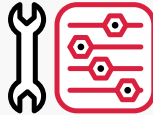

Spare parts



Augmented Reality / 3D



Service

PDF Product flyer

Item number

ATH M72 + A34 Plus WDK 151078

ATH M72 + A34 Plus WDK

Item number: 151078

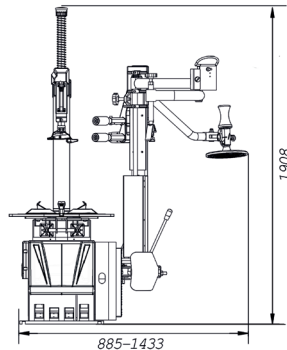
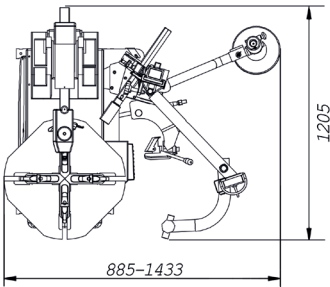

2 SPEEDS



Tested
according to wdk
mounting/dismounting
instructions
UHP and runflat tires

Wirtschaftsverband der
deutschen Kautschukindustrie e.V.



INDEX



ATH M72 + A34

- Rear swivel with pneumatic mounting head clamping including automatic vertical and horizontal Rim removal
- Control via ergonomically arranged foot pedals
- Including pneumatic controlled auxiliary assembly arm ATH A34 for effortless and damage-free assembly of low profile, UHP and run-flat tires
- Self-centering, pre-adjustable 4-jaw system with two double-acting aluminium clamping cylinders; Outside clamping range up to 26", 3-fold quick adjustment
- Lateral extractor with double-acting aluminium cylinder and anti-jamming system
- Ideally suited for car tires, with optional accessories also for motorcycle bikes

Technical details

Video



Clamping range inner / outer	11–30" / 9–26"
Rim width	4–13"
Max. wheel diameter	1.050 mm
Compressed air connection	10 bar
Bead breaking range	83–350 mm
Bead breaker force	2.500 kg
Mounting speeds	6 and 12 rpm
Driving power	0,75 / 0,90 kW
Power supply voltage	3x 400V / C16A
Noise level	70 dB(A)



Scope of delivery

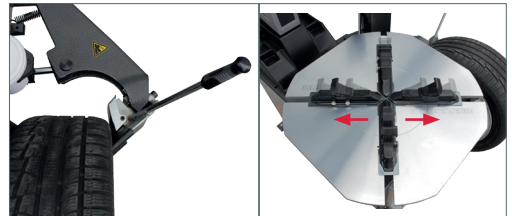

Anti-clamping system

Clamping range
3-way adjustable



Accessories



User manual

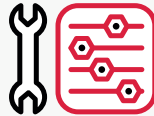

Spare parts



Augmented Reality / 3D



Service

PDF Product flyer

Item number

ATH M72 + A34

151072

ATH M72 + A34

Item number: 151072

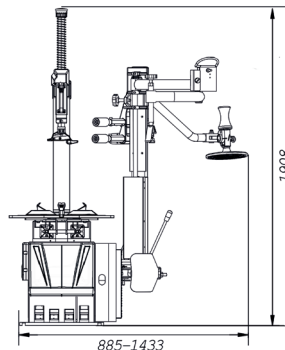
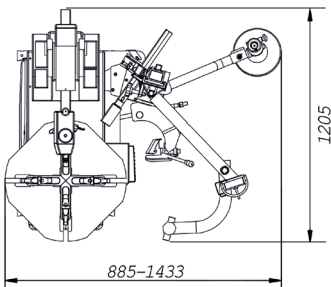

2 SPEEDS



WDK-capable with optional WDK kit (Article no.: RWK0001.01)

ATH-Heinl GmbH & Co. KG | Gewerbepark 9
D-92278 Illschwang | Germany | www.ath-heinl.com

Status: September 2023. Errors and mistakes excepted. Sale only through ATH distributors.



INDEX



55

ATH M52 + A34

- Rear swivel with pneumatic clamping mounting head, including automatic vertical and horizontal rim removal
- Control via ergonomically arranged foot pedals
- Including pneumatic controlled auxiliary assembly arm ATH A34 for effortless and damage-free assembly of low profile, UHP and run-flat tires
- Self-centering, pre-adjustable 4-jaw system with two double-acting aluminium clamping cylinders; Outside clamping range up to 22", additionally adjustable by -2"
- Lateral extractor with double-acting aluminium cylinder and anti-jamming system
- Ideally suited for car tires, with optional accessories also for motorcycle bikes



Technical details

Video



Clamping range inner / outer	14–26" / 12–22"
Rim width	4–13"
Max. wheel diameter	1.050 mm
Compressed air connection	10 bar
Bead breaking range	83–350 mm
Bead breaker force	2.500 kg
Mounting speeds	6 and 12 rpm
Driving power	0,75 / 0,90 kW
Power supply voltage	3x 400V / C16A
Noise level	70 dB(A)



Scope of delivery

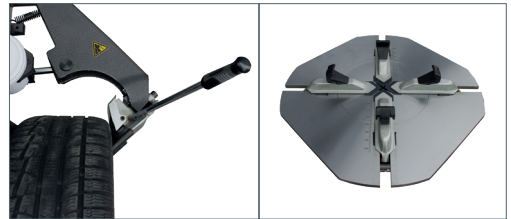

Anti-clamping system

Clamping range outside up to 22", additionally adjustable by -2"



Accessories



User manual

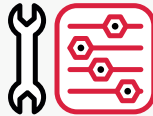

Spare parts



Augmented Reality / 3D



Service

PDF Product flyer

Item number

ATH M52 + A34

151071



ATH M52 + A34

Item number: 151071

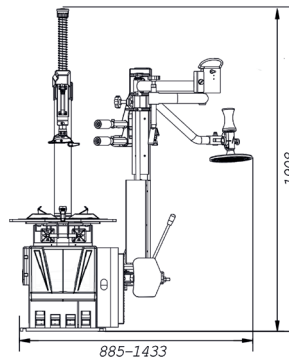
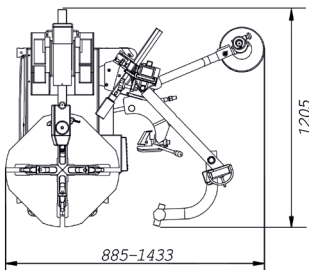

2 SPEEDS



WDK-capable with optional WDK kit (Article no.: RWK0001.01)

ATH-Heinl GmbH & Co. KG | Gewerbepark 9
D-92278 Illschwang | Germany | www.ath-heinl.com

Status: September 2023. Errors and mistakes excepted. Sale only through ATH distributors.



INDEX



57

ATH M52

- Rear swivel with pneumatic mounting head clamping including automatic vertical and horizontal rim removal
- Control via ergonomically arranged foot pedals
- Self-centering, pre-adjustable 4-jaw system with two double-acting aluminium Clamping cylinders; Outside clamping range up to 22", additionally adjustable by -2"
- Lateral extractor with double-acting aluminium cylinder and anti-jamming system
- Ideally suited for car tires, with optional accessories also for motorcycle bikes

Technical details

Video



Clamping range inner / outer	14–26" / 12–22"
Rim width	4–13"
Max. wheel diameter	1.050 mm
Compressed air connection	10 bar
Bead breaking range	83–350 mm
Bead breaker force	2.500 kg
Mounting speeds	6 and 12 rpm
Driving power	0,75 / 0,90 kW
Power supply voltage	3x 400V / C16A
Noise level	70 dB(A)



Scope of delivery

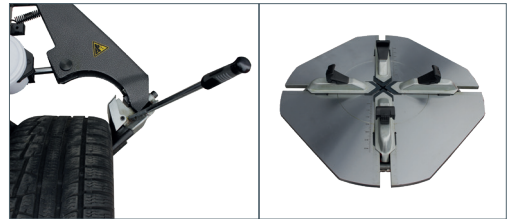

Anti-clamping system

Clamping range outside up to 22", additionally adjustable by -2"



Accessories



User manual

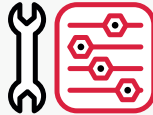

Spare parts



Augmented Reality / 3D



Service

PDF Product flyer

Item number

ATH M52

151032

ATH M52

Item number: 151032

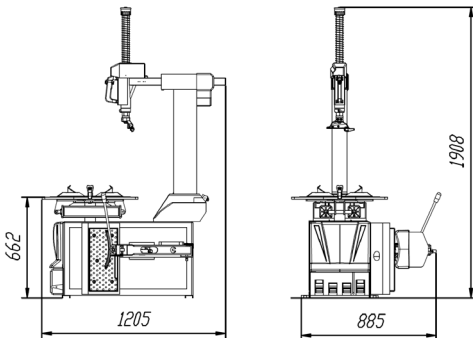

Scooter tire mounting with optional motorcycle kit Accessories.

WDK-capable with optional WDK kit (article no.: RWK0001.03) and optional auxiliary mounting arm ATH A34 (article no.: 151040.01)



ATH M33 + A24

- Tire changer with pneumatic rear swivel and pneumatic auxiliary assembly arm (right)
- Requires little space
- Large clamping range outside up to 22 "
- Pneumatic mounting head clamping
- Self-centering, pre-settable 4-jaw system with two double-acting aluminium clamping cylinders
- Lateral extractor with double-acting aluminum cylinder
- With hand tire inflator, tire lever and maintenance unit
- Ideally suited for car tires, with optional accessories also for motorcycle bikes

Technical details	Video 
Clamping range inner / outer	15–24" / 12–22"
Rim width	4–13"
Max. wheel diameter	1.000 mm
Compressed air connection	10bar
Bead breaking range	85–330 mm
Bead breaker force	2.350 kg
Mounting speeds	7 rpm
Driving power	1,1 kW
Power supply voltage	230V / C16A
Noise level	70 dB(A)

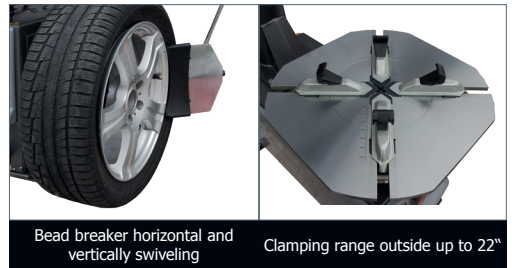

Accessories



User manual



Spare parts

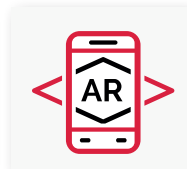

Augmented Reality / 3D



Service

PDF Product flyer	Item number
ATH M33 + A24	151049

ATH M33 + A24

Item number: 151049

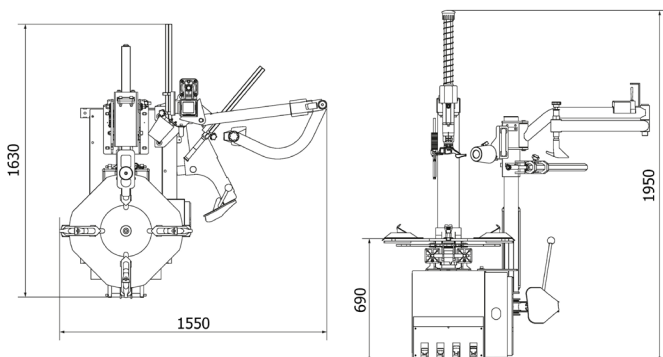

ATH M33

- Tire changer with pneumatic rear swivel
- Requires little space
- Large clamping range outside up to 22 „
- Pneumatic mounting head clamping
- Self-centering, pre-settable 4-jaw system with two double-acting aluminium clamping cylinders
- Lateral extractor with double-acting aluminium cylinder
- With hand tire inflator, tire lever and maintenance unit
- Ideally suited for car tires, with optional accessories also for motorcycle bikes

Technical details	Video 
Clamping range inner / outer	15–24" / 12–22"
Rim width	4–13"
Max. wheel diameter	1.000 mm
Compressed air connection	10 bar
Bead breaking range	85–330 mm
Bead breaker force	2.350 kg
Mounting speeds	7 rpm
Driving power	1,1 kW
Power supply voltage	230V / C16A
Noise level	70 dB(A)

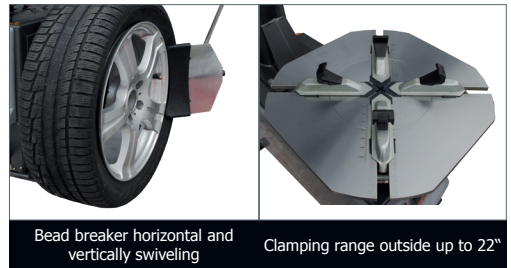

Accessories

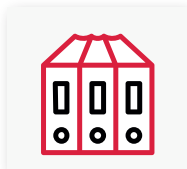

User manual



Spare parts

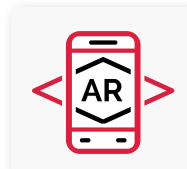

Augmented Reality / 3D



Service

PDF Product flyer	Item number
ATH M33	151048

ATH M33

Item number: 151048

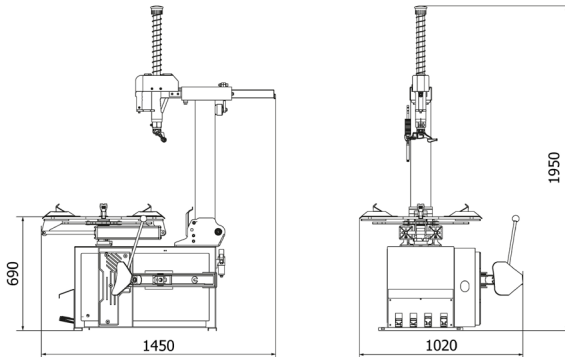

ATH M31

- Tire changer with 90 ° side swivel
- Outside clamping range up to 20 „
- Mechanical mounting head tensioner
- Self-centering, pre-settable 4-jaw system with two double-acting aluminium clamping cylinders
- Lateral extractor with double-acting aluminium cylinder
- Extendable valve block with aluminium valves and ergonomically arranged foot pedal control
- With hand tire inflator, tire lever and maintenance unit
- Ideally suited for car tires, with optional accessories also for motorcycle bikes

Technical details

Video 

Clamping range inner / outer	13–22" / 10–20"
Rim width	4–12"
Max. wheel diameter	950 mm
Compressed air connection	10 bar
Bead breaking range	75–305 mm
Bead breaker force	2.150 kg
Mounting speeds	7 rpm
Driving power	1,1 kW
Power supply voltage	230V / C16A
Noise level	70 dB(A)

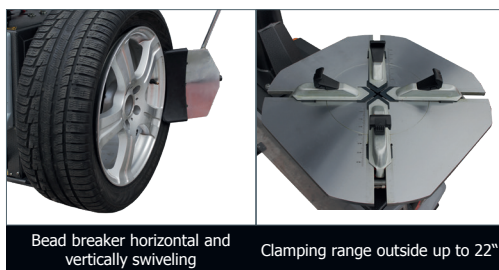

Accessories

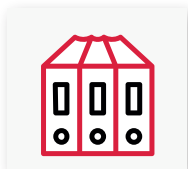

User manual



Spare parts

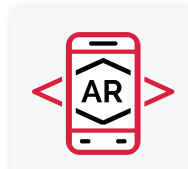

Augmented Reality / 3D



Service

PDF Product flyer

Item number

ATH M31

151047

ATH M31

Item number: 151047

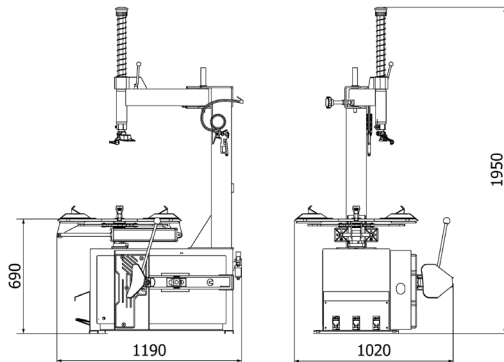

ATH 7256

- Electro-hydraulic drive for lifting, lowering and clamping with four clamping claws; electric rotation drive movement, hydraulic longitudinal movement of the slide
- Assembly arm and complete clamping arm device can be moved lengthways hydraulically, with automatic rotation and fold option
- Two working speeds (4 and 8 rpm)
- Wheels capacity up to 2550 mm diameter
- Movable control unit equipped with joysticks and foot pedals
- Ideally suited for truck and bus wheels, agricultural equipment and large construction machines up to 56" ,with optional accessories also for aluminium rims

Technical details	Video 
Clamping range	135–1.155 mm
Clamping range extended	710–1.550 mm
Rim diameter max.	56"
Wheel diameter max.	2.550 mm
Max. Wheel width	1.250 mm
Wheel weight max.	2.000 kg
Bead breaker force	8.000 kg
Driving power	3,3 / 4,0 kW
Power supply voltage	3x 400V / C16A
Noise level	65–85 dB(A)

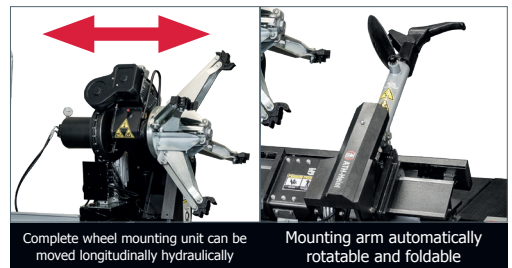

Accessories

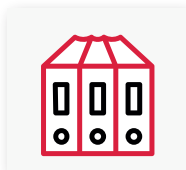

User manual



Spare parts



Augmented Reality / 3D



Service

PDF Product flyer	Item number
ATH 7256	721428

ATH 7256

Item number: 721428

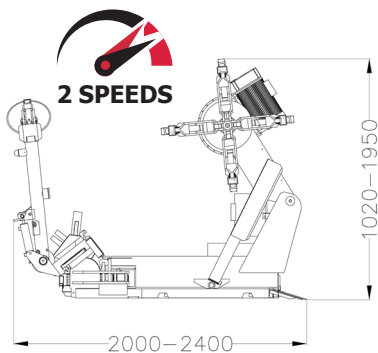
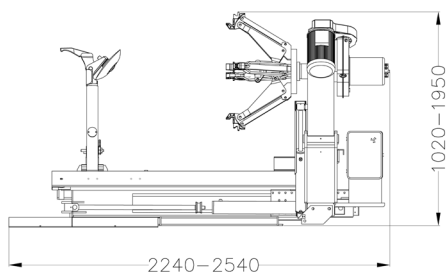
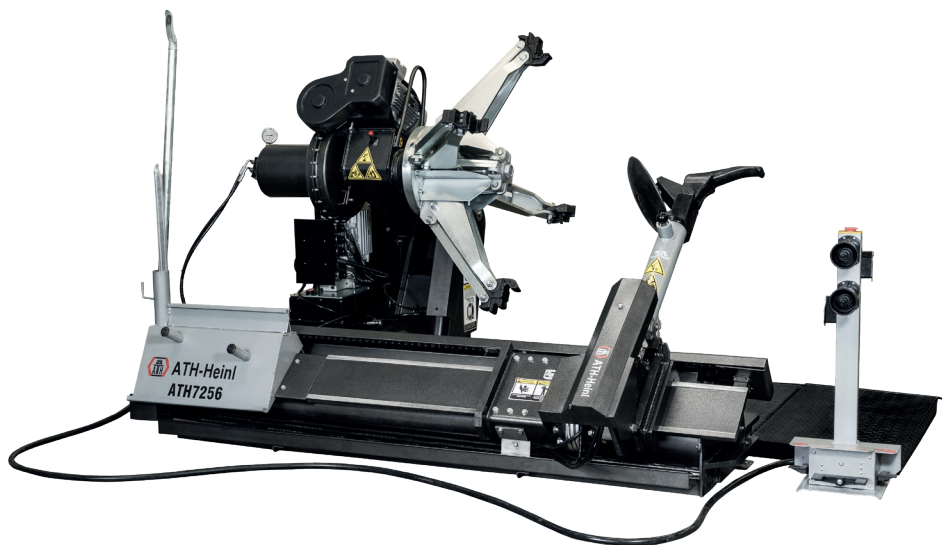

ATH 7226

- Electro-hydraulic lifting, lowering and clamping drive with four clamping claws; electric rotation drive movement, hydraulic longitudinal movement of the slide
- Mounting arm can be moved manually, and can be rotated and folded out manually
- Two working speeds (4 and 8 rpm)
- Wheels diameter up to 1,550 mm
- Movable control unit equipped with joystick and foot pedal
- Ideally suited for truck and bus wheels up to 26 ′′, with optional accessories also for aluminium rims

Technical details

Video



Clamping range	120–725 mm
Rim diameter max.	26"
Max. Wheel diameter	1.550 mm
Max. Wheel width	850 mm
Max. Wheel weight	1.000 kg
Bead breaker force	3.000 kg
Mounting speeds	4 and 8 rpm
Driving power	2,4 / 3,0 kW
Power supply voltage	3x 400V / C16A
Noise level	55–80 dB(A)

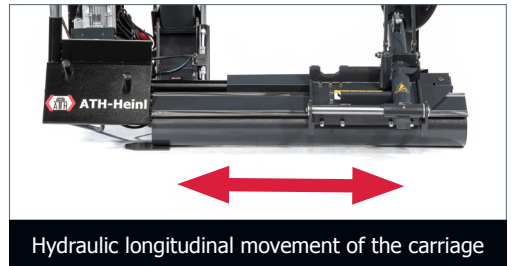

Accessories



User manual

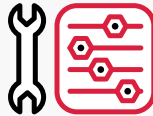

Spare parts



Augmented Reality / 3D



Service

PDF Product flyer

Item number

ATH 7226

721426

ATH 7226

Item number: 721426

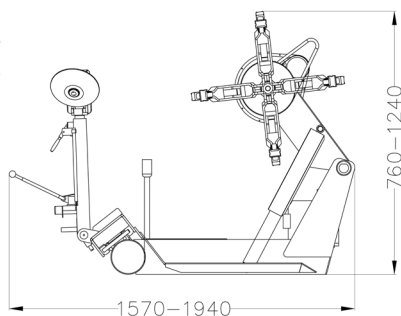
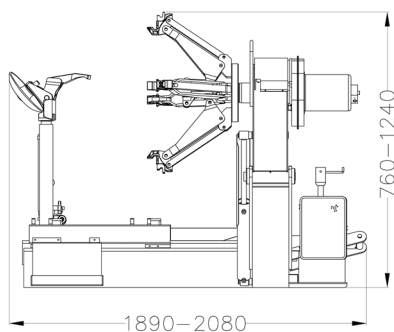

ATH W82 Touch 3D Plus

- Automatic distance, rim diameter and rim width (3D function) measurement
- Operation directly via 19 „touchscreen or ergonomically arranged front control panel
- Digital and optical position display of the weights via LCD touchscreen monitor and duo laser (LPS)
- Static / dynamic, ALU programs, ALU weight optimization and back spoke placement
- Pneumatic rim clamping with 40 mm shaft diameter („ATH-Quick-hold“), problem-free attachment of the weights via automatic, electronic parking brake („ATH-Easy-hold“), Measuring tool, integrated interior wheel lighting and incl. wheel lift
- Wheel protection with automatic start-stop function
- Ideally suited for car wheels, with optional accessories also for light truck wheels

Technical details

Video



Center hole diameter rim	45–130 mm
Measurement tolerance	± 1 g
Measuring time	7 s
Measuring speed	180 rpm
Rim width	1,5–20"
Rim diameter	12–24"
Max. Wheel diameter	900 mm
Max. Wheel weight	65 kg
Driving power	0,25 kW
Power supply voltage	230V / C16A



Scope of delivery

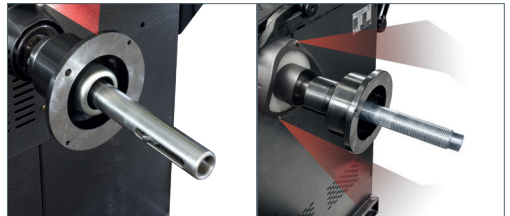

„ATH-Quick-hold“

Duo laser and light



Accessories



User manual

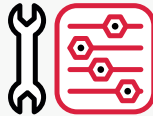

Spare parts



Augmented Reality / 3D



Service

PDF Product flyer

Item number

ATH W82 Touch 3D Plus

150036

ATH W82 Touch 3D Plus

Item number: 150036

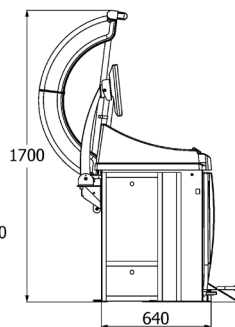
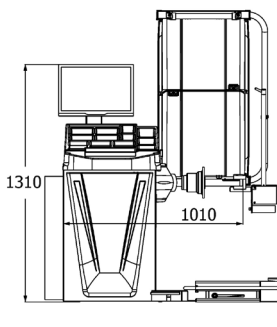
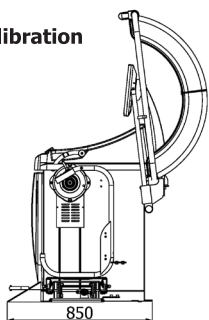

ATH W82 Touch 3D

- Automatic distance, rim diameter and rim width (3D function) measurement
- Operation directly via 19 „touchscreen or ergonomically arranged front control panel
- Digital and optical position display of the weights via LCD touchscreen monitor and duo laser (LPS)
- Static / dynamic, ALU programs, ALU weight optimization and back spoke placement
- Pneumatic rim clamping with 40 mm shaft diameter („ATH-Quick-hold“), problem-free attachment of the weights via automatic, electronic parking brake („ATH-Easy-hold“) and measuring tool, integrated interior wheel lighting
- Wheel protection with automatic start-stop function
- Ideally suited for car wheels, with optional accessories also for light truck wheels

Technical details

Video



Center hole diameter rim	45–130 mm
Measurement tolerance	± 1 g
Measuring time	7 s
Measuring speed	180 rpm
Rim width	1,5–20"
Rim diameter	12–24"
Max. Wheel diameter	900 mm
Max. Wheel weight	65 kg
Driving power	0,25 kW
Power supply voltage	230V / C16A

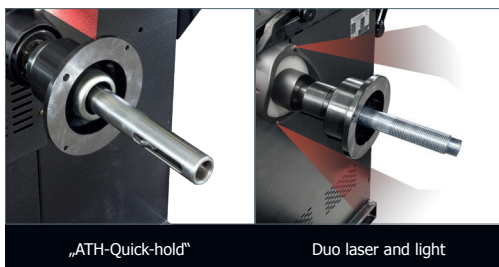
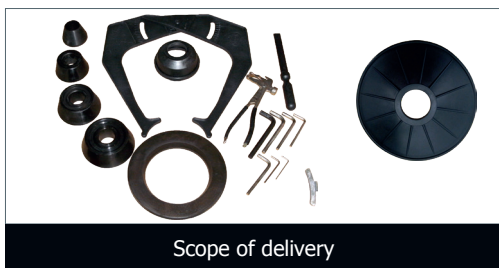

Accessories

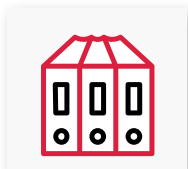

User manual



Spare parts

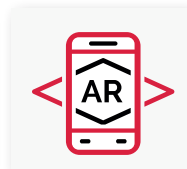

Augmented Reality / 3D



Service

PDF Product flyer

Item number

ATH W82 Touch 3D

150033

ATH W82 Touch 3D

Item number: 150033

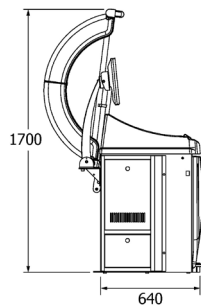
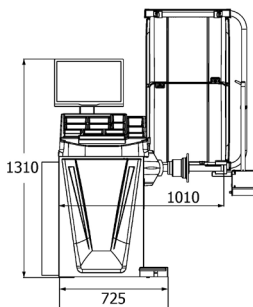
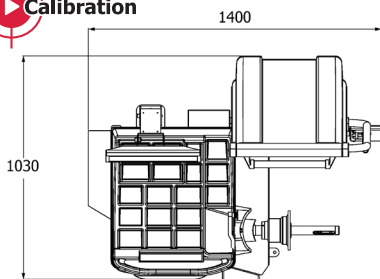

ATH W62 LCD 3D

- Automatic distance, rim diameter and rim width (3D function) measurement
- Operation via ergonomically arranged front control panel, large shelf with numerous compartments
- Digital and optical position display of the weights via LCD monitor and duo laser (LPS)
- Static / dynamic, ALU programs, ALU weight optimization and back spoke placement
- Quick-release nut clamping with 40 mm shaft diameter, easy attachment of the weights via pedal-operated parking brake and measuring tool, integrated interior wheel lighting
- Wheel protection with automatic start-stop function
- Precise work thanks to the latest microprocessor control
- Ideally suited for car wheels, with optional accessories also for motorcycle and light truck wheels

Technical details

Video



Center hole diameter rim	45–130 mm
Measurement tolerance	± 1 g
Measuring time	7 s
Measuring speed	180 rpm
Rim width	1,5–20"
Rim diameter	12–24"
Max. Wheel diameter	900 mm
Max. Wheel weight	65 kg
Driving power	0,25 kW
Power supply voltage	230V / C16A



Scope of delivery

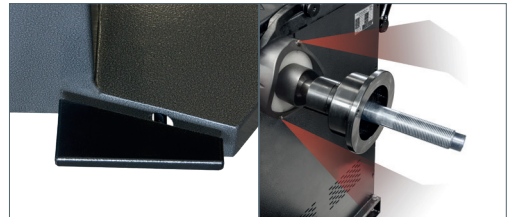

Pedal operated
Parking brake

Duo laser and light



Accessories



User manual

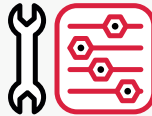

Spare parts



Augmented
Reality / 3D



Service

PDF Product flyer

Item number

ATH W62 LCD 3D

150035

ATH W62 LCD 3D

Item number: 150035

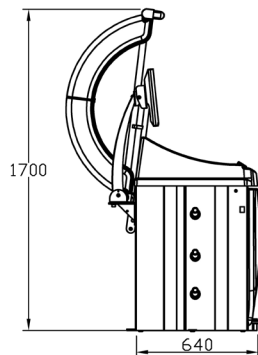
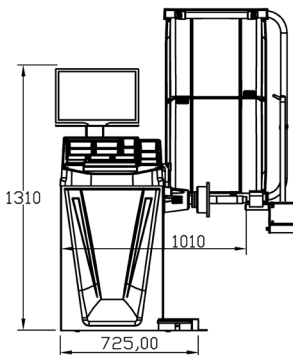
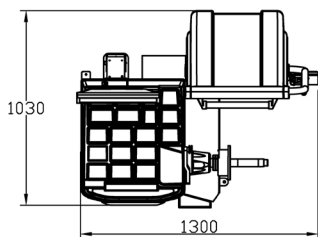

ATH W62 LCD 2D

- Automatic distance and rim diameter measurement, manual input of rim width (2D function)
- Operation via ergonomically arranged front control panel, large shelf with numerous compartments
- Digital and optical position display of the weights via LCD monitor and duo laser (LPS)
- Static / dynamic, ALU programs, ALU weight optimization and back spoke placement
- Quick-release nut clamping with 40 mm shaft diameter, easy attachment of the weights via pedal-operated parking brake and measuring tool, integrated interior wheel lighting
- Wheel protection with automatic start-stop function
- Precise work thanks to the latest microprocessor control
- Ideally suited for car wheels, with optional accessories also for motorcycle and light truck wheels

Technical details

Video



Center hole diameter rim	45–130 mm
Measurement tolerance	± 1 g
Measuring time	7 s
Measuring speed	180 rpm
Rim width	1,5–20"
Rim diameter	12–24"
Max. Wheel diameter	900 mm
Max. Wheel weight	65 kg
Driving power	0,25 kW
Power supply voltage	230V / C16A



Scope of delivery

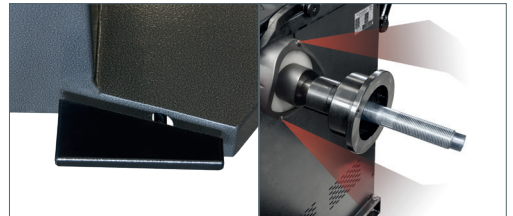

Pedal operated
Parking brake

Duo laser and light



Accessories



User manual

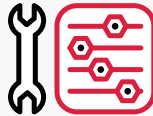

Spare parts



Augmented
Reality / 3D



Service

PDF Product flyer

Item number

ATH W62 LCD 2D

150034

ATH W62 LCD 2D

Item number: 150034

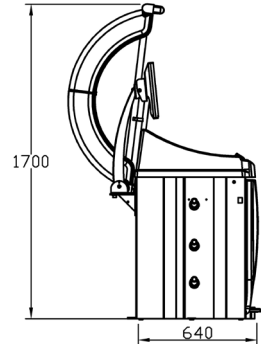
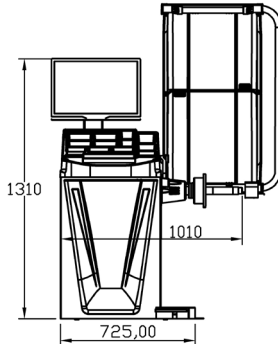
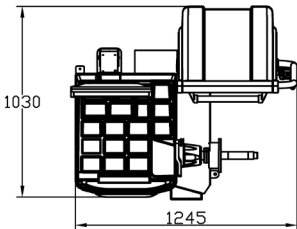

ATH W42 LED 3D

- Automatic distance, rim diameter and rim width (3D function) measurement
- Operation via ergonomically arranged front control panel, large shelf with numerous compartments
- Digital and optical position display of the weights via LED monitor and duo laser (LPS) 12/6 o'clock
- Static / dynamic, ALU programs, ALU weight optimization and back spoke placement
- Quick-release nut clamping with 40 mm shaft diameter, easy attachment of the weights via pedal-operated parking brake and measuring tool, integrated interior wheel lighting
- Wheel protection with automatic start-stop function
- Precise work thanks to the latest microprocessor control
- Ideally suited for car wheels, with optional accessories also for motorcycle and light truck wheels

Technical details

Video



Center hole diameter rim	45–130 mm
Measurement tolerance	± 1 g
Measuring time	7 s
Measuring speed	180 rpm
Rim width	1,5–20"
Rim diameter	12–24"
Max. Wheel diameter	900 mm
Max. Wheel weight	65 kg
Driving power	0,25 kW
Power supply voltage	230V / C16A



Scope of delivery

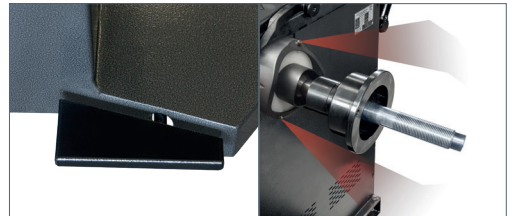

Pedal operated
Parking brake

Duo laser and light



Accessories



User manual

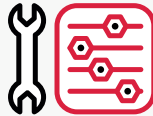

Spare parts



Augmented
Reality / 3D



Service

PDF Product flyer

Item number

ATH W42 LED 3D

150032

ATH W42 LED 3D

Item number: 150032

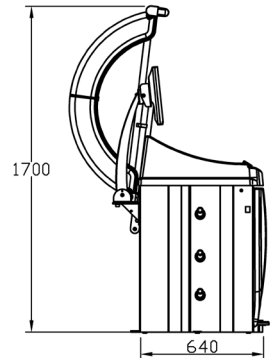
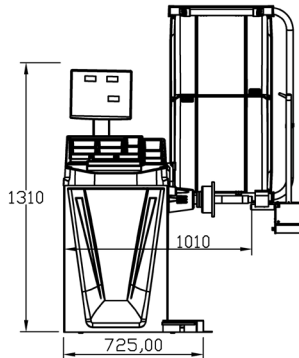
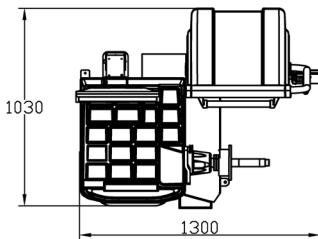

ATH W42 LED 2D

- Automatic distance and rim diameter measurement, manual input of rim width (2D function)
- Operation via ergonomically arranged front control panel, large shelf with numerous compartments
- Digital and optical position display of the weights via LED monitor and duo laser (LPS) 12/6 o'clock
- Static / dynamic, ALU programs, ALU weight optimization and back spoke placement
- Quick-release nut clamping with 40 mm shaft diameter, easy attachment of the weights via pedal-operated parking brake and measuring tool, integrated interior wheel lighting
- Wheel protection with automatic start-stop function
- Precise work thanks to the latest microprocessor control
- Ideally suited for car wheels, with optional accessories also for motorcycle and light truck wheels

Technical details

Video



Center hole diameter rim	45–130 mm
Measurement tolerance	± 1 g
Measuring time	7 s
Measuring speed	180 rpm
Rim width	1,5–20"
Rim diameter	12–24"
Max. Wheel diameter	900 mm
Max. Wheel weight	65 kg
Driving power	0,25 kW
Power supply voltage	230V / C16A



Scope of delivery

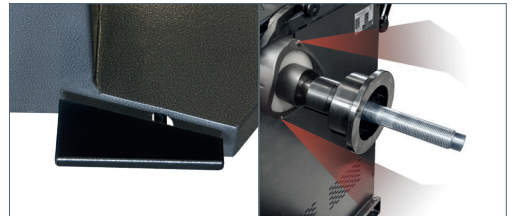

Pedal operated
Parking brake

Duo laser and light



Accessories



User manual

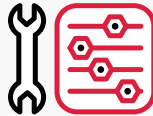

Spare parts



Augmented
Reality / 3D



Service

PDF Product flyer

Item number

ATH W42 LED 2D

150031

ATH W42 LED 2D

Item number: 150031



Calibration

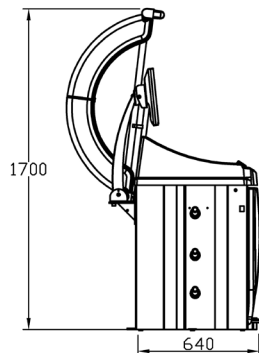
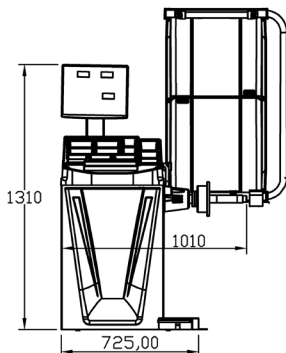
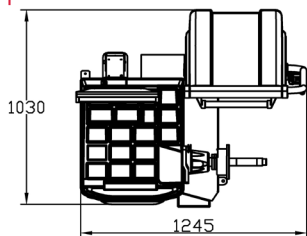

ATH W24 LED 2D

- Microprocessor-controlled balancing machine for car wheels with integrated calibration routine
- 2D function: automatic distance and wheel diameter measurement (manual input of the wheel width)
- Weight position display via the digital LED display
- Program selection between static and dynamic balancing, as well as various ALU programs, ALU weight optimization and rear spoke placement
- Pedal-operated parking brake for easy attachment of the weights
- Measuring arm made of aluminium with a special adhesive weight holder
- Ideally suited for car wheels, with optional accessories also for motorcycle and light truck wheels

Technical details

Video 

Center hole diameter rim	45–130 mm
Measurement tolerance	± 1 g
Measuring time	8 s
Measuring speed	200 rpm
Rim width	1,5–20"
Rim diameter	10–24"
Max. Wheel diameter	900 mm
Max. Wheel weight	65 kg
Driving power	0,20 kW
Power supply voltage	230V / C16A

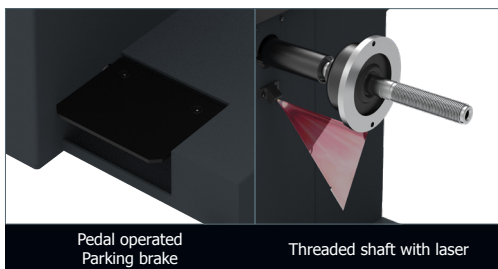

Accessories

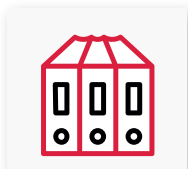

User manual



Spare parts

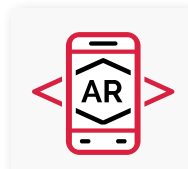

Augmented Reality / 3D



Service

PDF Product flyer

Item number

ATH W24 LED 2D

150051

ATH W24 LED 2D

Item number: 150051

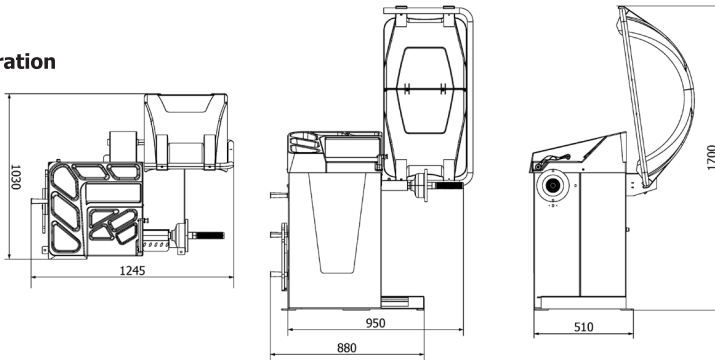

ATH W142

- Automatic distance and rim diameter measurement, manual input of rim width (2D function)
- Operation via ergonomically arranged front control panel, large shelf with numerous compartments
- Digital and optical position display of the weights via LED monitor and duo laser (LPS) 12/6 o'clock
- Automatic sequence with pneumatic wheel braking and selection between eleven balancing programs (static / dynamic / ALU programs in truck or car mode) and back spoke placement
- Electric drive with pneumatic wheel lift, easy attachment of the adhesive weights over measuring tool or laser position (6 o'clock), pneumatic parking brake
- Wheel protection with automatic start-stop function
- Ideally suited for truck, bus, van and car wheels

Technical details

Center hole diameter rim	45–290 mm
Measuring tolerance car truck	± 1 g ± 10 g
Measuring time car truck	13 s 25 s
Measuring speed	180 rpm
Rim width	5–20"
Rim diameter car truck	10–24" 15,5–30"
Max. Wheel diameter	1.200 mm
Max. Wheel weight	160 kg
Driving power	0,55 kW
Power supply voltage	3x 400V / C16A

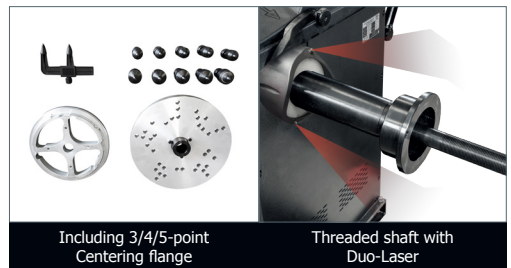

Accessories

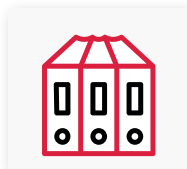

User manual



Spare parts

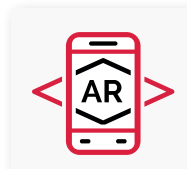

Augmented Reality / 3D



Service

PDF Product flyer

Item number

ATH W142

721603

ATH W142

Item number: 721603

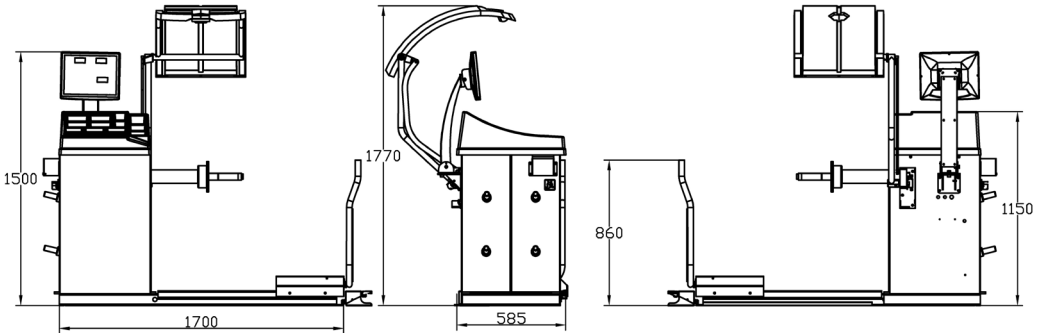

ATH W102

- Manual input of distance, rim diameter and rim width
- Operation via ergonomically arranged front control panel, large shelf with numerous compartments
- Digital position display of the weights via LED monitor
- Manual drive with hand brake and five balancing programs (static / dynamic / ALU programs in truck or car mode)
- No additional wheel lift required, as the complete balancing unit with the clamped wheel can be raised
- Ideally suited for truck, bus, van and car wheels



Technical details

Video



Center hole diameter rim	45–225 mm 270–281 mm
Measuring tolerance car truck	± 10 g ± 50 g
Shaft diameter	40 mm
Rim width	4–15"
Rim diameter	12–24"
Max. Wheel diameter	1.200 mm
Max. Wheel weight	200 kg
Operating voltage	230V / C16A
Weight net gross	185kg 221 kg



Accessories



User manual

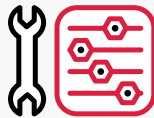

Spare parts



Augmented Reality / 3D



Service

PDF Product flyer

Item number

ATH W102

721602

ATH W102

Item number: 721602

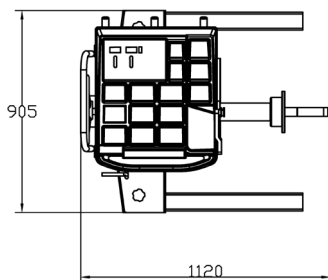
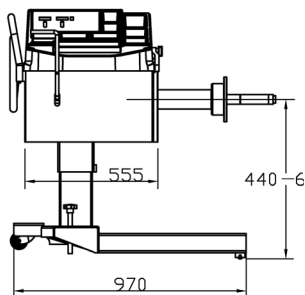
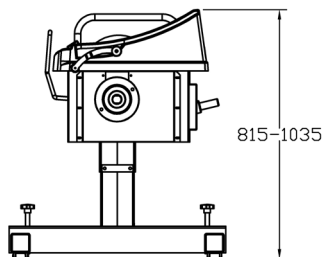

ATH-T15

Ideal for installing and removing vehicle components

- Electro-hydraulic drive 230V
- Powerful and smooth drive via remote control
- The holder is 60:40 split, can be levelled and removed
- Spindle adjustment for precise, stepless adjustment of the inclination
- Tool holes every 5mm instead of 10mm
- Including mobile kit via lifting drawbar
- flexible area of application
- High stability

Technical details

Load capacity	1.500 kg
Lifting height	1.810 mm
Pickup 60% range	928 x 810 mm
pickup 40% range	790 x 810 mm
Machine length	2.453 mm
Machine width	900 mm
Motor power	1,5 kW
Operating voltage	230V / C16A
Concrete strength	min. C20/25 Thickness: 120mm

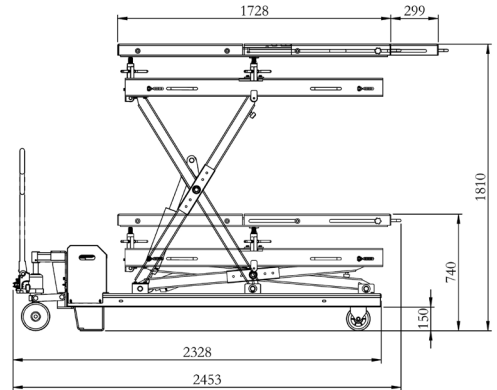

Accessories

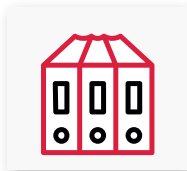

User manual



Spare parts



Augmented
Reality / 3D



Service

PDF Product flyer

Item number

ATH-T15

670023

ATH-T15

Item number: 670023

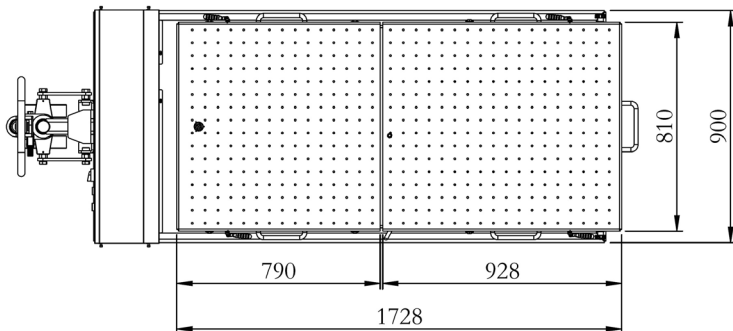

Wheel lift ATH RH120C

- Pneumatically controlled, without electrical components
- Tool holder for impact wrenches and sockets storing
- Catch hook to secure the wheels against falling
- Lockable swivel castors to fix the wheel holder

Technical details

Max. Load	65 kg
Max. Lifting height	1,2 m
Min. height of the room	2,8 m
Item number	450201



Accessories



User manual

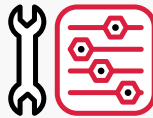

Spare parts



Augmented
Reality / 3D



Service

PDF Product flyer

Item number

ATH RH120C

450201



Axle jack ATH AF2500P2

- Air powered hydraulic scissor axle jack
- Suitable for assembly and use of ATH scissor lift and four post lift
- ATH double scissor lift and four post lift guide chassis included
- Pneumatic line and guide rope (attachment to the lift) included
- Plug-in system extensions 2x 80 mm and 2x 155 mm included
- Powerful air powered hydraulic unit
- Perfect corrosion protection with partial double powder coating

Technical details

Load capacity	2,5 t
Vehicle mount	665 - 1.625 mm
Rail support	830 - 1.120 mm
Lifting height	205 - 570 mm
Lifting / lowering time	approx. 20 s
Turntable adjustment range	30 - 85 mm
Compressed air connection	8 - 10 bar
Chassis mount	9 mm
Item number	1000002

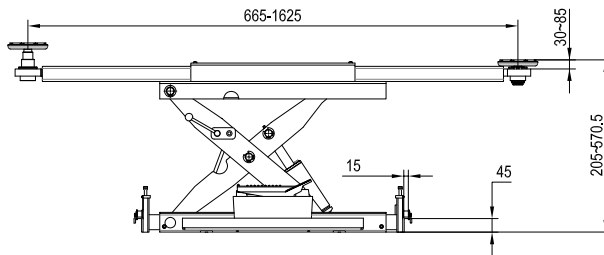

PDF Product flyer

Item number

ATH AF2500P2

1000002



Item no.
622803.20

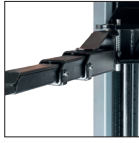

Item no.
622805.20

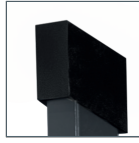

Item no.
HSA1252

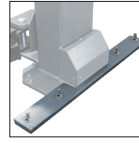

Item no.
HZB4006



Item no.
ATE2019-S



Item no.
ATE2018-S



Item no.
HTA2348
Master, Movano,
Interstar



Item no.
HTA2349
Jumper, Boxer,
Ducato



Item no.
HTA2351
Sprinter,
Crafter



Item no.
HTA2352
For vans with
Fixing point on the
vehicle frame



Item no.
631017.10



Item no.
HHS2010-3
from 2021



Item no.
HDA7210

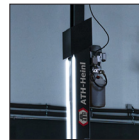

Item no.
622221



Item no.
HGB8167



Item no.
HTV2021

Accessories ATH Lifting

Accessories	Item no.
2-post lifts	
Lifting arms 3-parts long 3,5t (2 pieces)	622803.20
Lifting arms 3-parts long 4,0t (2 pieces)	622805.20
Support arm extension (4 pieces) for ATH Comfort Lift 2.55XL	HTV2021
Column hat ATH-Pure Lift 2.40(A) 230V/400V	HSA1252
Additional fastening kit for ATH Comfort Lift (3–4t) (2 pieces)	HZB4006
Adaptor extension 80mm for CL 2.35, 2.40, 2.55 (4 pieces)	ATE2019-S
Adaptor extension 155mm for CL 2.35, 2.40, 2.55 (4 pieces)	ATE2018-S
Adapter set for transporters set 1	HTA2348
Adapter set for transporters set 2	HTA2349
Adapter set for transporters set 3	HTA2351
Adapter set for transporters set 4	HTA2352
Long ramps made of high quality rubber granules (4 pieces)	631017.10
Holder for adapter extensions (Ø 50 mm) 2021	HHS2010-3
Energy set for Electric box sub-column	HES7114-S
Photoelectric beam switch set	HDA7210
Installing kit for 2-post-lifts	090599
1-post lifts	
Height quality rubber granulate long driving ramps	631017.10
Wheel lifting forks for ATH Single Lift 12P (4 pieces)	HGB8167
Installing kit for 1-post lift	090600
Photoelectric beam switch set	HDA7210



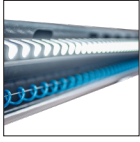

Item no.
629020



Item no.
1000002



Item no.
HNS2153



Item no.
HVA2154

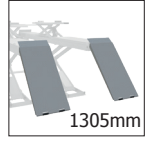

Item no.
1000003.01

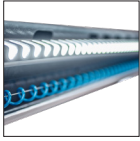

Item no.
629023



Item no.
HSK8500.10



Item no.
HVA2160
Four Lift 55

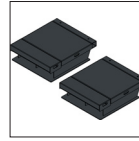

Item no.
HVA2161
Four Lift 55

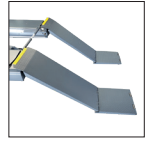

Item no.
HVA2150
Cross Lift



Item no.
HFP8533.01

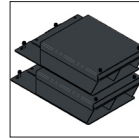

Item no.
HVA2162
Four Lift 64

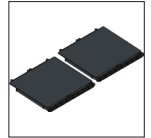

Item no.
HVA2163
Four Lift 64

Accessories ATH Lifting

Accessories

Item no.

4-post lifts

LED lighting kit for 4-post lift 2022	629020
Rolling jack ATH AF2500P2	1000002
Pick-Up adapter kit for scissors lifts	HSK8500.10
Installing kit for 4-post lifts	090601
Extensions for ramp ATH Four Lift 55P, 55AP, 55HP, 55HAP	HVA2160
Extensions for drive-on ramps ATH Four Lift 55P, 55AP, 55HP, 55HAP	HVA2161
Extensions for drive-on ramps ATH Four Lift 64P, 64AP	HVA2162

Drive-on scissor lifts

Platform extension (600 mm)	HVA2154
Kit for surface installing Cross Lift 40 / 50 (Plus) (drive-on ramps and cover plates)	1000003.01
Extensions for drive-on ramps (640 mm)	HVA2150
LED lighting kit for ATH Cross Lift 40 / 50	629020
LED lighting kit for ATH Cross Lift 35	629023
Wheel alignment kit for ATH-Cross Lift 35	631006
Rolling jack ATH AF2500P2	1000002
Leveling Supports for ATH Cross Lift 40 / 50 (Plus)	HNS2153
Pick-Up adapter kit for scissors lifts	HSK8500.10
In-ground + wheel alignment - kit for ATH Cross Lift 35	631003
Anti-slip coating	HRB1023
Installing kit for scissor lifts	090601



Item no.
HUK2200

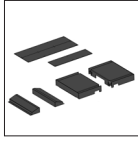

Item no.
HUK2201

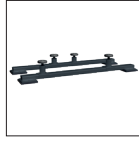

Item no.
HSK8500.10

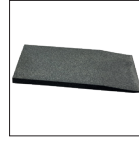

Item no.
631017.10



Item no.
710050



Item no.
HRH2150



Item no.
670032



Item no.
670025

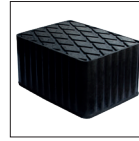

Item no.
HGA1421



Item no.
HGA1422



Accessories ATH Lifting

Accessories	Item no.
Double scissor lifts	
In-ground - installation kit for ATH Frame Lift 30FZ	HUK2200
In-ground - installation kit for ATH Frame Lift 35FZ	HUK2201
Pick-Up adapter kit for scissors lifts	HSK8500.10
Long ramps made of high quality rubber granules (4 pieces)	631017.10
Installing kit for scissor lifts	090601
Mid-rise lifts	
Long ramps (galvanized & coated 4 pcs)	631009.20
Pick-Up adapter kit for scissors lifts	HSK8500.10
Long ramps made of high quality rubber granules (4 pieces)	631017.10
Installing kit for scissor lifts	090601
Motorcycle lifts	
ATV Adapter Set 7Q	670032
Mini Motorcycle Lift ATH MMH450 (for ATH-Bike Lift 7F)	670025
Pneumatic wheel clamp F-version of ATH-Bike Lift	HRH2150
Installing kit for scissor lifts	090601
Mobile column lifts	
Support frame ATH 8,5-1950	710050
Rubber pads	
Rubber pads 160 x 120 x 80 mm	HGA1421
Rubber pads 160 x 120 x 40 mm	HGA1422



Item no.
151040.01



Item no.
151046



Item no.
RWK0001.01



Item no.
RMK0932



Item no.
RMK0748.10

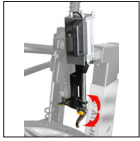

Item no.
151044



Item no.
RSF0766



Item no.
RFS0839



Item no.
RRH1109

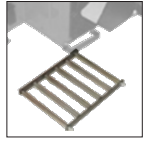

Item no.
RRB1000



Item no.
RWN0846



Item no.
RWN0847



Item no.
152303

Accessories ATH Changing

Accessories

Item no.

Car tire changers

Assist mounting arm ATH A34	151040.01
Assist mounting arm ATH A24	151046
WDK kit for ATH M72+A34 / ATH M52+A34	RWK0001.01
Pneumatic mounting finger for M-Series	151044
Pneumatic mounting finger with fast connection system for M-Series	151045
Fast connection system for mounting head M-series	RSF0766
Wheel lift for wheel balancers M72/M52	RRH1109
Plastic mounting head (Ø 28.25 mm receptacle)	RMK0932
Steel mounting head for external spokes (Ø receptacle 28.25 mm)	RMK0748.10
Bead holder clamp	RWN0846
Bead holder clamp PRO	RWN0847
Rolling plate for car tire changers	RRB1000
Car tire inflator/bomb ATH RB 20-3 for M series	152303
Rim flange protection	RFS0839





Item no.
RMK0758



Item no.
RMK0753.10



Item no.
RMK0760



Item no.
RMK0761



Item no.
RMS0862.10

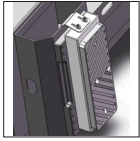

Item no.
RMS0913



Item no.
RRH1107

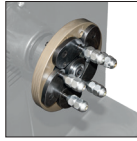

Item no.
RUF0186



Item no.
RMF0115

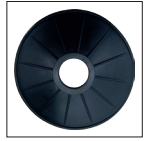

Item no.
RSD0187



Item no.
RKO0093.01

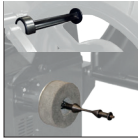

Item no.
RMF1085.10

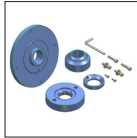

Item no.
RMF1090

Accessories ATH

Changing and Balancing

Accessories	Item no.
Motorcycle tire mounting	
Motorcycle mounting head (receptacle Ø 28.25 mm)	RMK0758
Motorcycle/scooter mounting head (receptacle Ø 28.25 mm)	RMK0753.10
Motorcycle clamping claws (M52) (4 pieces)	RMK0760
Motorcycle clamping claws (M72) (4 pieces)	RMK0761
Motorcycle push-off blade long	RMS0862.10
Motorcycle push-off rubber attachable	RMS0913
Car wheel balancers	
Wheel lifter for balancers	RRH1107
Universal flange for W62, W42	RUF0186
Measuring arm for width gauge (W62 LCD 2D, W42 LED 2D)	RMF0115
Large clamping hood for alloy rims for 40 mm quick clamping nut (W-series)	RSD0187
Cone LLKW (114 - 171 mm)	RKO0093.01
Motorcycle Wheel Balancers	
Motorcycle flange and motorcycle measuring tip (W62, W42)	RMF1085.10
Motorcycle flange BMW-Ducati (W62, W42)	RMF1090

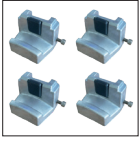

Item no.
RAS1211



Item no.
721423

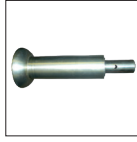

Item no.
RAR1110

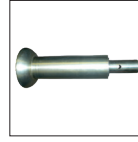

Item no.
RAR1111



Item no.
RLF0922



Item no.
RLF0923



Item no.
RLF0924



Item no.
RLF0925-1



Item no.
152301



Item no.
RSF0009

Accessories ATH Changing, Balancing and Equipment

Accessories	Item no.
Truck tire changers	
Truck aluminum clamping jaws (7256, 7226)	RAS1211
Bead retainer clamp for truck aluminum wheels	721423
Bead breaking roller (7226)	RAR1110
Bead breaking roller (7256)	RAR1111
Clamping ring for truck aluminum wheels Ø 175 mm	RLF0922
Clamping ring for truck aluminum rims Ø 201 mm	RLF0923
Clamping ring for truck wheels Ø 220 mm	RLF0924
Clamping ring for truck tire rims Ø 280 mm (with O-ring)	RLF0925-1
Truck tire inflator/bomb ATH RB40	152301
Truck Wheel Balancers	
3/4/5-point centering flange ATH W102	RSF0009



Lifting Changing Balancing Equipment

Ivan Milojkovic

International Account Manager

+49 (0)9666-1880139

ivan.m@ath-heinl.com



Marcin Stramowski

Eastern Europe Manager

+48 797 737 615

marcin.stramowski@ath-heinl.pl



ATH-Heinl GmbH & Co. KG

Gewerbepark 9

92278 Illschwang

Tel.: +49 (0) 9666 18801-00

Fax: +49 (0) 9666 18801-01

info@ath-heinl.de

www.ath-heinl.com

