

FALCO EVO 624 S



it Lista dei ricambi de Ersatzteilliste
en Spare part list es Listas de piezas de recambio

Class	----- de -----	----- en -----	----- fr -----	----- es -----	----- it -----
●	Verschleißteil: Definition: Zu erwartende Lebensdauer des Teiles ist kleiner als die zu erwartende Lebensdauer des Produktes! - Bei Ausfall nicht mehr funktionsfähig oder sicherer Einsatz des Produktes nicht mehr gewährleistet - Verminderte Gewährleistung - Wir empfehlen, diese Ersatzteile im lokalem Lager zu bevorzugen. Hinweis: Der Verschleiß und das Wartungsintervall sind abhängig von: - der Einsatzzeit - Art und Häufigkeit der Verwendung - Alter der Maschine	Wearing part: Definition: The expected lifetime of the part is shorter than the expected lifetime of the product! - In the event of failure, no longer functional or safe use of product no longer guaranteed - Reduced warranty - We recommend stocking these replacement parts in the local warehouse. Note: Wear and the maintenance interval depend on: - Usage time - Nature and frequency of use - Age of machine	Pièce d'usure : Définition : La durée de vie prévisible de la pièce est inférieure à la durée de vie prévisible du produit ! - Plus en ordre de marche en cas de panne ou utilisation sûre du produit plus garantie - Garantie réduite - Nous conseillons d'avoir ces pièces de rechange en réserve dans un entrepôt local. Remarque : L'usure et l'intervalle d'entretien dépendent des facteurs suivants : - durée d'utilisation - nature et fréquence de l'utilisation - âge de la machine	Pieza de desgaste: Definición: La vida útil esperada de la pieza es menor que la vida útil esperada del producto. - En caso de avería ya no está en condiciones de funcionar o el uso seguro del producto ya no se garantiza - Garantía reducida - Se recomienda almacenar esas piezas de recambio en un almacén local. Nota: El desgaste y el intervalo de mantenimiento dependen: - del tiempo de servicio - del tipo y frecuencia de uso - de la edad de la máquina	Parte soggetta a usura: Definizione: Il ciclo di vita prevedibile del componente è inferiore al ciclo di vita prevedibile del prodotto. - In caso di avaria il prodotto non è più in grado di funzionare oppure non ne è più garantita la sicurezza d'impiego - Garanzia ridotta - Consigliamo di tenere una scorta di questi ricambi nel magazzino ocale. Avvertenza: l'usura e l'intervallo di manutenzione dipendono da: - tempo operativo - tipo e frequenza dell'impiego - età della macchina
○	Funktionsteil: Definition: Die zu erwartende Lebensdauer des Teiles ist gleich oder größer als die zu erwartende Lebensdauer des Produktes! - Bei Ausfall nicht mehr funktionsfähig oder sicherer Einsatz des Produktes nicht mehr gewährleistet - Standard Gewährleistung - Wir empfehlen, diese Ersatzteile im lokalem Lager zu bevorzugen.	Function part: Definition: The expected lifetime of the part is the same as or longer than the expected lifetime of the product! - In the event of failure, no longer functional or safe use of product no longer guaranteed - Standard warranty - We recommend stocking these replacement parts in the local warehouse.	Pièce fonctionnelle : Définition : La durée de vie prévisible de la pièce est égale ou supérieure à la durée de vie prévisible du produit ! - Plus en ordre de marche en cas de panne ou utilisation sûre du produit plus garantie - Garantie standard - Nous conseillons d'avoir ces pièces de rechange en réserve dans un entrepôt local.	Pieza funcional: Definición: La vida útil esperada de la pieza es igual o mayor que la vida útil esperada del producto. - En caso de avería ya no está en ndiciones de funcionar o el uso seguro del producto ya no se garantiza - Garantía estándar - Se recomienda almacenar esas piezas de recambio en un almacén local.	Parte funzionale: Definizione: Il ciclo di vita prevedibile del componente è uguale o superiore al ciclo di vita prevedibile del prodotto. - In caso di avaria il prodotto non è più in grado di funzionare oppure non ne è più garantita la sicurezza d'impiego - Garanzia standard - Consigliamo di tenere una scorta di questi ricambi nel magazzino locale.
○	Nicht-Funktionsteil: Definition: Die zu erwartende Lebensdauer des Teiles ist gleich oder größer als die zu erwartende Lebensdauer des Produktes! - Bei Ausfall weiterhin funktionsfähig und ein sicherer Einsatz des Produktes ist gewährleistet - Standard Gewährleistung - Wir empfehlen, diese Ersatzteile bei einem Bedarf über das Zentrallager zu bestellen.	Non-function part: Definition: The expected lifetime of the part is the same as or longer than the expected lifetime of the product! - In the event of failure, still functional and safe use of the product is guaranteed - Standard warranty - We recommend ordering these replacement parts as required via the central warehouse.	Pièce non fonctionnelle : Définition : La durée de vie prévisible de la pièce est égale ou supérieure à la durée de vie prévisible du produit ! - Toujours en ordre de marche en cas de panne et utilisation sûre du produit garantie - Garantie standard - Nous recommandons de commander ces pièces de rechange au besoin par le biais de l'entrepôt central.	Pieza no funcional: Definición: La vida útil esperada de la pieza es igual o mayor que la vida útil esperada del producto. - En caso de avería aún en condiciones de funcionar y el uso seguro del producto se garantiza - Garantía estándar - Se recomienda pedir esas piezas de recambio al almacén central, en caso de necesidad.	Parte non funzionale: Definizione: Il ciclo di vita prevedibile del componente è uguale o superiore al ciclo di vita prevedibile del prodotto. - In caso di avaria il prodotto continua ad essere in grado di funzionare e ne rimane garantita la sicurezza d'impiego - Garanzia standard - Consigliamo di ordinare questi ricambi in caso di necessità attraverso il magazzino centrale.

Intervall	Wartungsintervall des Verschleißteiles	Maintenance interval for wearing part	Intervalle d'entretien de la pièce d'usure	Intervalo de mantenimiento de la pieza de desgaste	Intervallo di manutenzione della parte soggetta a usura
h	Stunden	hours	heures	Horas	ore
d	Tage	days	jours	Días	giorni
m	Monate	month	mois	Meses	mesi
cy	Zyklen	cycles	cycles	Ciclos	cicli
-	ohne definiertes Wartungsintervall	No defined maintenance interval	pas d'intervalle d'entretien défini	Sin intervalo de mantenimiento definido	senza intervallo di manutenzione definito

Customer	Austausch des Teiles durch den Kunden (Werkstatt)	Replacement of part by customer (workshop)	Remplacement de la pièce par le client (atelier)	Sustitución de la pieza por el cliente (taller)	La sostituzione del componente da parte del cliente (officina)
-	ist nicht erlaubt.	Not permissible.	pas autorisé	no está permitida.	non è ammessa.
x	ist erlaubt (Diese Ersatzteile sind auch in der Betriebsanleitung aufgeführt)	Permissible (these replacement parts are also listed in the operating instructions)	autorisé (ces pièces de rechange sont également indiquées dans la notice)	está permitida (estas piezas de recambio también se indican en las instrucciones de	è ammessa (questi ricambi sono riportati anche nelle istruzioni d'uso)

Part-number	Bestellnummer des Ersatzteiles oder Verweis auf ein Standardteil	Order number of replacement part or reference to standard part	Référence de commande de la pièce de rechange ou signalement de pièce normalisée	Número de pedido de la pieza de recambio o nota sobre la pieza normalizada	Codice di ordinazione del ricambio o avvertenza sul componente unificato
Normpart	Normteil: Ersatzteile, die normalerweise über unterschiedliche Kanäle bezogen werden können wie z. B. Schrauben, Muttern, O-Ringe, Tintenpatronen. Alle 3 Ersatzteil-Kategorien (siehe Class) sind möglich	Normpart (Standard part): Replacement parts which can normally be obtained through various channels e.g. bolts, nuts, O-rings, ink cartridges. All 3 replacement part categories (refer to Class) are possible	Pièce normalisée : Pièces de rechange qui peuvent normalement être obtenues par le biais de différents canaux, par ex. les vis, écrous, joints toriques, cartouches d'encre. Les 3 catégories de pièces de rechange (voir Class) sont possibles	Pieza normalizada: Piezas de recambio que se pueden adquirir normalmente a través de diferentes vías, p. ej., tornillos, tuercas, anillos de sección circular, cartuchos de tinta. Las tres categorías de piezas de recambio (véase clase) son posibles.	Parte unificata (componente unificato): Si tratta di ricambi che in genere possono essere acquistati attraverso diversi canali, come ad es. viti, dadi, O-ring, cartucce di inchiostro. Sono possibili tutte e 3 le categorie di ricambi (vedi Class)

Bezeichnung Designation Dénomination Designación	Bestellnummer Partnumber Référence Núm.depedido	Gefertigt von Production since fabrication de fabricación de	Gefertigt bis produced until fabrication fabricación	Ersatzteilkpflicht bis Service part obligation Obligation de pièce de rechange Obligación de disp. de piezas de recambio	Bemerkungen Notes Notes Notas
FALCO EVO 624 S	1694302430	ago-18			400V, 3PH, 50Hz Ral colour 3000 (Red) 2 Speed rotation of the plate 24 inch working table Pole not mounted
FALCO EVO 624 S (V5)	1694302431	ago-18			400V, 3PH, 50Hz Ral colour 3000 (Red) 2 Speed rotation of the plate 24 inch working table Manual bead breaker Pole not mounted
FALCO EVO 624 S (V1)	1694302432	ago-18			400V, 3PH, 50Hz Ral colour 3000 (Red) 2 Speed rotation of the plate 24 inch working table TECNOROLLER NG mounted
FALCO EVO 624 S (V6)	1694302433	ago-18			400V, 3PH, 50Hz Ral colour 3000 (Red) 2 Speed rotation of the plate 24 inch working table Manual bead breaker TECNOROLLER NG mounted
FALCO EVO 624 S (V3)	1694302434	ago-18			400V, 3PH, 50Hz Ral colour 3000 (Red) 2 Speed rotation of the plate 24 inch working table Manual bead breaker Pneumatic retracting for the vertical slide Pole not mounted
FALCO EVO 624 S	1694302440	ago-18			230V, 1 PH, 50-60Hz Ral colour 3000 (Red) 2 Speed rotation of the plate 24 inch working table Pole not mounted
FALCO EVO 624 S (V5)	1694302441	ago-18			230V, 1 PH, 50-60Hz Ral colour 3000 (Red) 2 Speed rotation of the plate 24 inch working table Manual bead breaker Pole not mounted

Bezeichnung Designation Dénomination Designación	Bestellnummer Partnumber Référence Núm.depedido	Gefertigt von Production since fabrication de fabricación de	Gefertigt bis produced until fabrication fabricación	Ersatzteilkpflicht bis Service part obligation Obligation de pièce de rechange Obligación de disp. de piezas de recambio	Bemerkungen Notes Notes Notas
FALCO EVO 624 S (V1)	1694302442	ago-18			230V, 1 PH, 50-60Hz Ral colour 3000 (Red) 2 Speed rotation of the plate 24 inch working table TECNOROLLER NG mounted
FALCO EVO 624 S (V6)	1694302443	ago-18			230V, 1 PH, 50-60Hz Ral colour 3000 (Red) 2 Speed rotation of the plate 24 inch working table Manual bead breaker TECNOROLLER NG mounted
FALCO EVO 624 S	1694302448	ago-18			230V, 1 PH, 50-60Hz Ral colour 3000 (Red) 2 Speed rotation of the plate 24 inch working table Pole not mounted Japanese version
FALCO EVO 624 S (V5)	1694302450	ago-18			230V, 1 PH, 50-60Hz Ral colour 3000 (Red) 2 Speed rotation of the plate 24 inch working table Manual bead breaker Pole not mounted Japanese version
FALCO EVO 624 S	1694302452	ago-18			110V, 1 PH, 50-60 Hz Ral colour 3000 (Red) 2 Speed rotation of the plate 24 inch working table Pole not mounted
FALCO EVO 624 S (V5)	1694302453	ago-18			110V, 1 PH, 50-60 Hz Ral colour 3000 (Red) 2 Speed rotation of the plate 24 inch working table Manual bead breaker Pole not mounted
FALCO EVO 624 S (V1)	1694302454	ago-18			110V, 1 PH, 50-60 Hz Ral colour 3000 (Red) 2 Speed rotation of the plate 24 inch working table TECNOROLLER NG mounted

Bezeichnung Designation Dénomination Designación	Bestellnummer Partnumber Référence Núm.depedido	Gefertigt von Production since fabrication de fabricación de	Gefertigt bis produced until fabrication fabricación	Ersatzteilkpflicht bis Service part obligation Obligation de pièce de rechange Obligación de disp. de piezas de recambio	Bemerkungen Notes Notes Notas
FALCO EVO 624 S (V6)	1694302455	ago-18			110V, 1 PH, 50-60 Hz Ral colour 3000 (Red) 2 Speed rotation of the plate 24 inch working table Manual bead breaker TECNOROLLER NG mounted
FALCO EVO 624 S	1694302480	set-18			400V, 3PH, 50Hz Ral colour 5015 (Blue) 2 Speed rotation of the plate 24 inch working table
FALCO EVO 624 S (V5)	1694302481	set-18			400V, 3PH, 50Hz Ral colour 5015 (Blue) 2 Speed rotation of the plate 24 inch working table Manual bead breaker
FALCO EVO 624 S	1694302484	set-18			230V, 1PH, 50-60Hz Ral colour 5015 (Blue) 2 Speed rotation of the plate 24 inch working table
FALCO EVO 624 S (V5)	1694302485	set-18			230V, 1PH, 50-60Hz Ral colour 5015 (Blue) 2 Speed rotation of the plate 24 inch working table Manual bead breaker
FALCO EVO 624 S (V5)	1694302512	nov-18			400V, 3PH, 50Hz Ral colour 3000 (Red) 2 Speed rotation of the plate 24 inch working table Manual bead breaker Pneumatic retracting for the vertical slide
FALCO EVO 624 S	1694302516	nov-18			230V, 1PH, 50-60Hz Ral colour 3000 (Red) 2 Speed rotation of the plate 24 inch working table
FALCO EVO 624 S (V5)	1694302517	nov-18			230V, 1PH, 50-60Hz Ral colour 3000 (Red) 2 Speed rotation of the plate 24 inch working table Manual bead breaker

Motors 1 and 3 Ph, 50 Hz								
Pos.	50 Hz	FALCO EVO 600 S		FALCO EVO 620 S		FALCO EVO 600 S MOTO FALCO EVO 624 S FALCO ECO 628 S		FALCO EVO 630 S
		230/1	400/3	230/3	400/3	230/1	400/3	230/1
1	1 695 041 323							
	1 695 040 602	x	x	x	x		x	
	1 695 040 496							
	1 695 000 346					x		x
2	1 695 100 634					x		x
	1 695 100 593	x	x	x	x		x	
	1 695 100 722							
	1 695 005 013							
3	230 V / 1 PH							
	1 695 042 914							
	1 695 042 845	x						
	1 695 000 332					x		x
	230 V / 3 PH							
	1 695 042 815			x				
	1 695 043 014							
	1 695 042 916							
	400 V / 3 PH							
	1 695 042 913		x		x		x	
	1 695 042 938							
	1 695 040 075							
230 / 400 V / 3 PH								
1 695 005 012								
4	1 695 041 292							
5	230 V / 1 PH							
	1 695 000 334					x		x

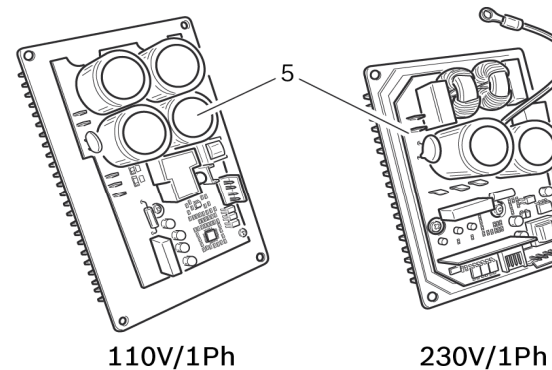
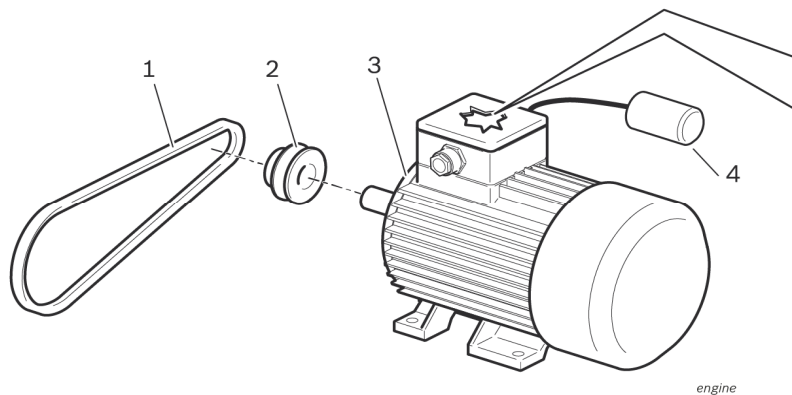

Motors 1 and 3 PH / 60 Hz								
Pos.	60 Hz	FALCO EVO 600 S		FALCO EVO 620 S	FALCO EVO 600 S MOTO FALCO EVO 624 S FALCO EVO 628 S			FALCO EVO 630 S
		110/1	230/1	110/1	110/1	230/1	400/3	230/1
1	1 695 041 323							
	1 695 040 602	x	x	x			x	
	1 695 040 496							
	1 695 000 346				x	x		x
2	1 695 100 634				x	x		x
	1 695 005 013	x		x			x	
	1 695 100 722		x					
3	400 V/3 PH							
	1 695 042 913						x	
	110 V/1 PH							
	1 695 000 336				x			
	1 695 042 915	x		x			x	
	230 V/1 PH							
	1 695 042 622		x					
	1 695 042 782							
1 695 000 332					x		x	
230 V/3 PH								
4	1 695 041 362					x		
	1 695 042 193							
	1 695 041 292							
	1 695 041 363							
5	110 V / 1 PH							
	1 695 000 335				x			
	230 V / 1 PH							
	1 695 000 334					x		x

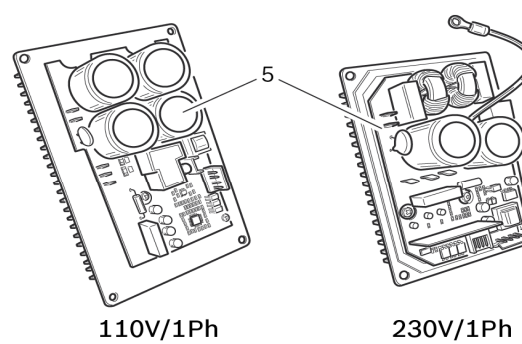
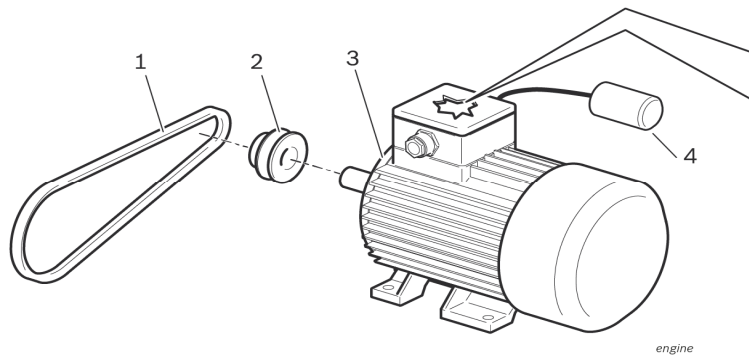

Pos.	Class	Intervall	Customer	Partnumber	IDENTIFICAZIONE (it)	BEZEICHNUNG (de)	Drawing
					IDENTIFICATION (en)	IDENTIFICACION (es)	
					Comment (en)		
1	●	-	-	1695108310	Composto saldato	Schweissbaugruppe	
					Welded assembly	Montaje soldado	
2	●	-	-	1695108197	Set Di Ricambi	Ersatzteilsortiment	
					Spares Set	Surtido De Piezas De Rec	
3	●	-	-	1695107507	Cilindro Pneumatico	PN-Zylinder	
					Compressed-Air Cylinder	Cilindro Para Aire A Pr	
4	●	-	-	1695102036	Set Di Ricambi	Ersatzteilsortiment	
					Spares Set	Surtido De Piezas De Rec	
5	●	-	-	1695102037	Set Di Ricambi	Ersatzteilsortiment	
					Spares Set	Surtido De Piezas De Rec	
6	●	-	-	1695101862	Slitta	Schlitten	
					Slide	Carro	
7	○	-	-	1695107508	Lamiera	Blech	
					Plate	Chapa	
8	●	-	-	1695101866	Scorrevole	Gleiter	
					sliding element	Patin	
9	●	-	-	1695101901	Barra Piatta	Flachstab	
					Flat bar	Barra Plana	
10	●	-	-	1695101899	Composto saldato	Schweissbaugruppe	
					Welded assembly	Montaje soldado	

Pos.	Class	Intervall	Customer	Partnumber	IDENTIFICAZIONE (it)	BEZEICHNUNG (de)	Drawing
					IDENTIFICATION (en)	IDENTIFICACION (es)	
					Comment (en)		
1	①	-	-	1695102665	Distributore Di Aria	Luftverteiler	
					Air Distributor	Distribuidor De Aire	
2	●	-	-	1695100500	Ingranaggio	Getriebe	
					Gear	Engranaje	
3	①	-	-	1695108761	Supporto Del Motore	Motorträger	
					Motor Carrier	Soporte De Motor	
801	①	-	-	1695106886	Serie Parti	Teilesatz	
					Parts Set	Juego De Piezas	
802	①	-	-	1695106884	Serie Parti	Teilesatz	
					Parts Set	Juego De Piezas	
803	①	-	-	1695108961	Kit Pezzi Di Ricambio	Ersatzteilsatz	
					Service kit	Juego De Repuestos	
804	①	-	-	1695108962	Kit Pezzi Di Ricambio	Ersatzteilsatz	
					Service kit	Juego De Repuestos	
100	●	-	-	Several numbers	Elettromotore	Elektromotor	
					Motor	Motor	
					see "Motors"		

Pos.	Class	Intervall	Customer	Partnumber	IDENTIFICAZIONE (it)	BEZEICHNUNG (de)	Drawing
					IDENTIFICATION (en)	IDENTIFICACION (es)	
					Comment (en)		
1	●	24 m	X	1695101150	Piastra Di Gomma	Gummiplatte	
					Rubber Plate	Plancha De Goma	
2	●	-	-	Normpart	Vite bombata esagonale	Innensechsktflachkopfschr	
					Hex Socket Button Screw	Tornillo abombada hex	
					ISO 4762 M8x14		
3	●	-	-	1695102973	Copertura di plastica	Kunststoffabdeckung	
					plastic covering	cubierta de plástico	
3*	●	-	-	1695103000	Ral 3000 (red)		
					Copertura di plastica	Kunststoffabdeckung	
3**	●	-	-	1695102952	plastic covering	cubierta de plástico	
					Ral 7040 (grey)		
3***	●	-	-	1695102997	Copertura di plastica	Kunststoffabdeckung	
					plastic covering	cubierta de plástico	
4	●	-	-	1695108797	Ral 5015 (blue)		
					Protezione	Schutz	
5	○	-	-	1695101051	Protection	Protección	
					Lamiera	Blech	
6	●	-	-	Normpart	Plate	Chapa	
					Rivet	Remache De Encastre	
					DIN 7337 4,8x12x10		
7	●	-	-	1695101095	Lamiera	Blech	
					Plate	Chapa	

Pos.	Class	Intervall	Customer	Partnumber	IDENTIFICAZIONE (it)	BEZEICHNUNG (de)	Drawing
					IDENTIFICATION (en)	IDENTIFICACION (es)	
					Comment (en)		
8	O	-	-	Normpart	Rondella piana	Unterlegscheibe	
					Plain Washer	Arandela plana	
					ISO 7093 5,5x15x1,5		
9	●	-	-	Normpart	Vite bombata esagonale	Innensechsktflachkopfschr	
					Hex Socket Button Screw	Tornillo abombada hex	
					ISO 7380-2 M6x16		
801	O	-	-	1695106853	Serie Parti	Teilesatz	
					Parts Set	Juego De Piezas	
802	O	-	-	1695101547	Set Di Ricambi	Ersatzteilsortiment	
					Spares Set	Surtido De Piezas De Rec	
					Ral 3000 (red)		
802*	O	-	-	1695101583	Set Di Ricambi	Ersatzteilsortiment	
					Spares Set	Surtido De Piezas De Rec	
					Ral 7040 (grey)		
802**	O	-	-	1695101551	Set Di Ricambi	Ersatzteilsortiment	
					Spares Set	Surtido De Piezas De Rec	
					Ral 5015 (blue)		
803	●	-	-	1695104634	Set Di Ricambi	Ersatzteilsortiment	
					Spares Set	Surtido De Piezas De Rec	
804	●	-	-	1695104635	Set Di Ricambi	Ersatzteilsortiment	
					Spares Set	Surtido De Piezas De Rec	
805	O	-	-	1695101525	Set Di Ricambi	Ersatzteilsortiment	
					Spares Set	Surtido De Piezas De Rec	

Pos.	Class	Intervall	Custome	Partnumber	IDENTIFICATION (it)	IDENTIFICATION (fr)	Drawing
					IDENTIFICATION (en)	IDENTIFICACION (es)	
					Comment (it)	Comment (en)	
1	●	-	-	Normpart	Rondella piana	Unterlegscheibe	
					Plain Washer	Arandela plana	
					ISO 7089 12		
2	●	-	-	1695106645	Molla	Feder	
					Spring	Resorte	
3	●	-	-	Normpart	Vite Con Intaglio A Croce	Kreuzschlitzschraube	
					Cross Recessed-Head Screw	Tornillo Ranura Crucif.	
					ISO 1207 M3x40		
4	●	-	-	1695043289	Microinterruttore	Mikroschalter	
					Microswitch	Microinterruptor	
5	●	-	-	1695105921	Camma	Nocken	
					Cam	Tope De Mando	
6	●	-	-	Normpart	Vite Cilindrka	Schaftschraube	
					Headless Screw	Piton Roscado	
					ISO 4029 M5x5		
7	●	-	-	Normpart	Disco	Scheibe	
					Washer	Arandela	
					ISO 7089 6		
8	●	-	-	Normpart	Vite cilindrica esagonal	Innensechskantschraube	
					Hex Socket Head Cap Screw	Tornillo cilíndrica hex	
					ISO 4762 M5x45		
9	●	-	-	1695105927	Pedale	Pedal	
					Pedal	Pedal	
10	●	-	-	Normpart	Accessorio	Zubehörteil	
					Accessory Part	Accesorio	
					EN 10511 M6		

Pos.	Class	Intervall	Custome	Partnumber	IDENTIFICATION (it)	IDENTIFICATION (fr)	Drawing
					IDENTIFICATION (en)	IDENTIFICACION (es)	
					Comment (it)	Comment (en)	
11	●	-	-	Normpart	Dado autobloccante Self-locking nut EN 10512 M3	Sicherungsmutter Tuerca autoblocante	
801	●	-	-	1695101527	Set Di Ricambi Spares Set	Ersatzteilsortiment Surtido De Piezas De Rec	

Pos.	Class	Intervall	Customer	Partnumber	IDENTIFICAZIONE (it)	BEZEICHNUNG (de)	Drawing
					IDENTIFICATION (en)	IDENTIFICACION (es)	
					Comment (en)		
1	●	-	-	1695001204	Albero	Welle	
					Shaft	Eje	
2	●	-	-	1695001226	Molla	Feder	
					Spring	Resorte	
3	●	-	-	1695001230	Molla	Feder	
					Spring	Resorte	
4	●	-	-	1695040902	Silenziatore	Schalldämpfer	
					Silencer	Silenciador	
5	⓪	-	-	1695100112	Gruppo Di Leve	Hebelgruppe	
					Lever Group	Grupo De Palancas	
6	⓪	-	-	1695100115	Gruppo Di Leve	Hebelgruppe	
					Lever Group	Grupo De Palancas	
7	⓪	-	-	1695100119	Gruppo Di Leve	Hebelgruppe	
					Lever Group	Grupo De Palancas	
8	●	-	-	1695100136	Copertura	Abdeckung	
					Cover	Cubierta	
9	●	-	-	1695001394	Valvola Pneumatica	PN-Ventil	
					Pneumatic Operated Valve	Valvula Neumatica	
10	●	-	-	1695001395	Valvola Pneumatica	PN-Ventil	
					Pneumatic Operated Valve	Valvula Neumatica	

Pos.	Class	Intervall	Customer	Partnumber	IDENTIFICAZIONE (it)	BEZEICHNUNG (de)	Drawing
					IDENTIFICATION (en)	IDENTIFICACION (es)	
					Comment (en)		
1	●	-	-	1695001204	Albero	Welle	
					Shaft	Eje	
2	●	-	-	1695001226	Molla	Feder	
					Spring	Resorte	
3	●	-	-	1695001230	Molla	Feder	
					Spring	Resorte	
4	●	-	-	1695040902	Silenziatore	Schalldämpfer	
					Silencer	Silenciador	
5	⓪	-	-	1695101944	Tappo	Pfropfen	
					Stopper	Tapón	
6	⓪	-	-	1695100115	Gruppo Di Leve	Hebelgruppe	
					Lever Group	Grupo De Palancas	
7	⓪	-	-	1695100119	Gruppo Di Leve	Hebelgruppe	
					Lever Group	Grupo De Palancas	
8	●	-	-	1695100136	Copertura	Abdeckung	
					Cover	Cubierta	
9	⓪	-	-	1695108901	Pedaliere	Pedalwerk	
					Pedal Unit	Grupo De Pedales	
10	●	-	-	1695001395	Valvola Pneumatica	PN-Ventil	
					Pneumatic Operated Valve	Valvula Neumatica	

Pos.	Class	Intervall	Customer	Partnumber	IDENTIFICAZIONE (it)	BEZEICHNUNG (de)	Drawing
					IDENTIFICATION (en)	IDENTIFICACION (es)	
					Comment (en)		
1	①	-	-	1695101495	Pedaliere	Pedalwerk	
					Pedal Unit	Grupo De Pedales	
2	①	-	-	1695100115	Gruppo Di Leve	Hebelgruppe	
					Lever Group	Grupo De Palancas	
3	●	-	-	1695001226	Molla	Feder	
					Spring	Resorte	
4	①	-	-	1695104091	Barra tonda di acciaio	Rundstahl	
					Rod Steel	Acero Redondo	
5	①	-	-	1695107489	Gruppo Valvola	Ventil-Zusammenbau	
					Valve assembly	Conj. Valvula	
801	①	-	-	1695101527	Set Di Ricambi	Ersatzteilsortiment	
					Spares Set	Surtido De Piezas De Rec	
802	●	-	-	1695041254	Serie Parti	Teilesatz	
					Parts Set	Juego De Piezas	

PedaL_pneu_V14a_BM

Pos.	Class	Intervall	Customer	Partnumber	IDENTIFICAZIONE (it)	BEZEICHNUNG (de)	Drawing
					IDENTIFICATION (en)	IDENTIFICACION (es)	
					Comment (en)		
1	●	-	-	1695101147	Barra Esagonale D'acciaio Hexagonal Steel Bar	Sechskantstahl Acero Hexagonal	
2	●	-	-	1695602600	Base Di Gomma Rubber Base	Gummifuss Base De Goma	
3	●	-	-	1695102297	Scorrevole sliding element	Gleiter Patín	
4	●	-	-	1695101108	Vite Screw	Schraube Tornillo	
801	●	-	-	1695107148	Kit Pezzi Di Ricambio Service kit	Ersatzteilsatz Juego De Repuestos	
802	●	-	-	1695100837	Sottogruppo Sub-assembly	Unterbaugruppe Subgrupo	
803	●	-	-	1695101535	Set Di Ricambi Spares Set Ral 7016 (grey)	Ersatzteilsortiment Surtido De Piezas De Rec	

Pos.	Class	Intervall	Customer	Partnumber	IDENTIFICAZIONE (it)	BEZEICHNUNG (de)	Drawing
					IDENTIFICATION (en)	IDENTIFICACION (es)	
					Comment (en)		
804	●	-	-	1695101544	Set Di Ricambi	Ersatzteilsortiment	
					Spares Set	Surtido De Piezas De Rec	
					Ral 3000 (Red)		
804*	●	-	-	1695101548	Set Di Ricambi	Ersatzteilsortiment	
					Spares Set	Surtido De Piezas De Rec	
					Ral 5015 (Blue)		
804**	●	-	-	1695101579	Set Di Ricambi	Ersatzteilsortiment	
					Spares Set	Surtido De Piezas De Rec	
					Ral 7016 (Grey)		
804** *	●	-	-	1695101586	Set Di Ricambi	Ersatzteilsortiment	
					Spares Set	Surtido De Piezas De Rec	
					Ral 7040 (Grey)		
805	●	-	-	1695101537	Set Di Ricambi	Ersatzteilsortiment	
					Spares Set	Surtido De Piezas De Rec	
806	●	-	-	1695104085	Guida Tubi Flessibili	Schlauchführung	
					Hose Guide	Guia Para Manguera	
807	●	-	-	1695106691	Serie Parti	Teillesatz	
					Parts Set	Juego De Piezas	
808	●	-	-	1695101538	Set Di Ricambi	Ersatzteilsortiment	
					Spares Set	Surtido De Piezas De Rec	
809	●	-	-	1695101539	Set Di Ricambi	Ersatzteilsortiment	
					Spares Set	Surtido De Piezas De Rec	

Pos.	Class	Intervall	Customer	Partnumber	IDENTIFICAZIONE (it)	BEZEICHNUNG (de)	Drawing
					IDENTIFICATION (en)	IDENTIFICACION (es)	
					Comment (en)		
1	●	-	-	1695108978	Kit Pezzi Di Ricambio	Ersatzteilsatz	
					Service kit	Juego De Repuestos	
					Ral 7016 (Grey)		
2	●	-	-	1695108767	Cilindro Pneumatico	PN-Zylinder	
					Compressed-Air Cylinder	Cilindro Para Aire A Pr	
801	●	-	-	1695101541	Set Di Ricambi	Ersatzteilsortiment	
					Spares Set	Surtido De Piezas De Rec	
802	●	-	-	1695101542	Set Di Ricambi	Ersatzteilsortiment	
					Spares Set	Surtido De Piezas De Rec	
803	●	-	-	1695108751	Kit Pezzi Di Ricambio	Ersatzteilsatz	
					Service kit	Juego De Repuestos	
804	●	-	-	1695108968	Kit Pezzi Di Ricambio	Ersatzteilsatz	
					Service kit	Juego De Repuestos	
805	●	-	-	1695101530	Set Di Ricambi	Ersatzteilsortiment	
					Spares Set	Surtido De Piezas De Rec	
806	●	-	-	1695101531	Set Di Ricambi	Ersatzteilsortiment	
					Spares Set	Surtido De Piezas De Rec	
807	●	-	-	1695101532	Set Di Ricambi	Ersatzteilsortiment	
					Spares Set	Surtido De Piezas De Rec	
					Ral 7016 (Grey)		

Pos.	Class	Intervall	Customer	Partnumber	IDENTIFICAZIONE (it)	BEZEICHNUNG (de)	Drawing
					IDENTIFICATION (en)	IDENTIFICACION (es)	
					Comment (en)		
808	●	-	-	1695101545	Set Di Ricambi	Ersatzteilsortiment	
					Spares Set	Surtido De Piezas De Rec	
					Ral 3000 (Red)		
808*	●	-	-	1695101549	Set Di Ricambi	Ersatzteilsortiment	
					Spares Set	Surtido De Piezas De Rec	
					Ral 5015 (Blue)		
808**	●	-	-	1695101580	Set Di Ricambi	Ersatzteilsortiment	
					Spares Set	Surtido De Piezas De Rec	
					Ral 7016 (Grey)		
808** *	●	-	-	1695101584	Set Di Ricambi	Ersatzteilsortiment	
					Spares Set	Surtido De Piezas De Rec	
					Ral 7040 (Grey)		
809	●	-	-	1695101546	Set Di Ricambi	Ersatzteilsortiment	
					Spares Set	Surtido De Piezas De Rec	
					Ral 3000 (Red)		
809*	●	-	-	1695101550	Set Di Ricambi	Ersatzteilsortiment	
					Spares Set	Surtido De Piezas De Rec	
					Ral 5015 (Blue)		
809**	●	-	-	1695101581	Set Di Ricambi	Ersatzteilsortiment	
					Spares Set	Surtido De Piezas De Rec	
					Ral 7016 (Grey)		
809** *	●	-	-	1695101585	Set Di Ricambi	Ersatzteilsortiment	
					Spares Set	Surtido De Piezas De Rec	
					Ral 7040 (Grey)		
810	●	-	-	1695108750	Kit Pezzi Di Ricambio	Ersatzteilsatz	
					Service kit	Juego De Repuestos	

Pos.	Class	Intervall	Customer	Partnumber	IDENTIFICAZIONE (it)	BEZEICHNUNG (de)	Drawing
					IDENTIFICATION (en)	IDENTIFICACION (es)	
					Comment (en)		
1	●	-	-	1695001082	Modulo Cilindro	Zylinderbaueinheit	
					Cylinder Assembly Unit	Unidad Constr. Cilindro	
2	●	-	-	1695001083	Copertura	Abdeckung	
					Cover	Cubierta	
3	●	-	-	1695001085	Flangia cilindro pneumatico	Zylinderflansch	
					Cylinder Flange	Brida Para Cilindros	
4	●	-	-	1695901368	Braccio	Arm	
					Arm	Brazo	
5	●	-	-	1695101571	Cilindro Pneumatico	PN-Zylinder	
					Compressed-Air Cylinder	Cilindro Para Aire A Pr	
6	●	-	-	1695108681	Perno	Kloben	
					Block	Gozne	
7	●	-	-	1695104977	Telescopio	Teleskop	
					Telescope	Telescopio	
8	●	-	-	1695100641	Molla	Feder	
					Spring	Resorte	
9	●	-	-	1695100297	Rondella	Reduzierscheibe	
					Reducer Shim	Arandela De Reduccion	
10	●	-	-	1695001229	Molla	Feder	
					Spring	Resorte	

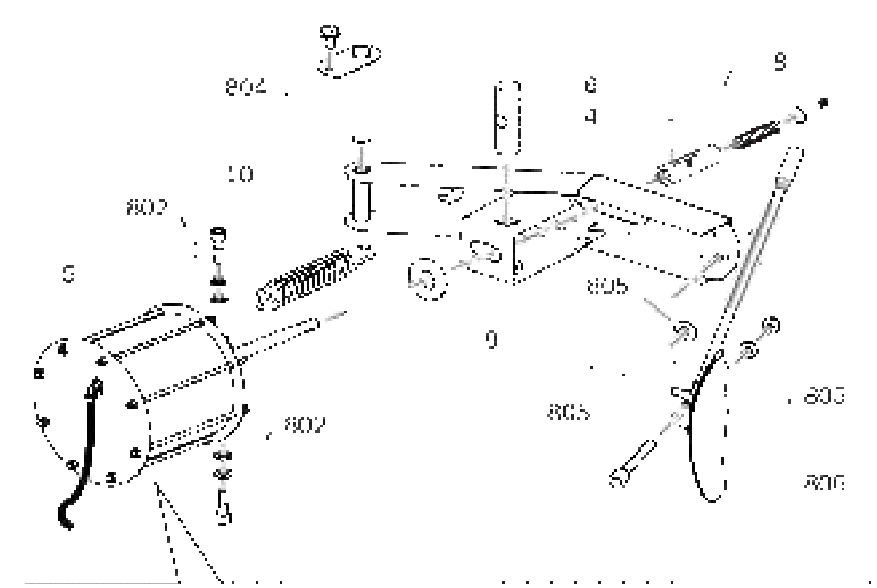
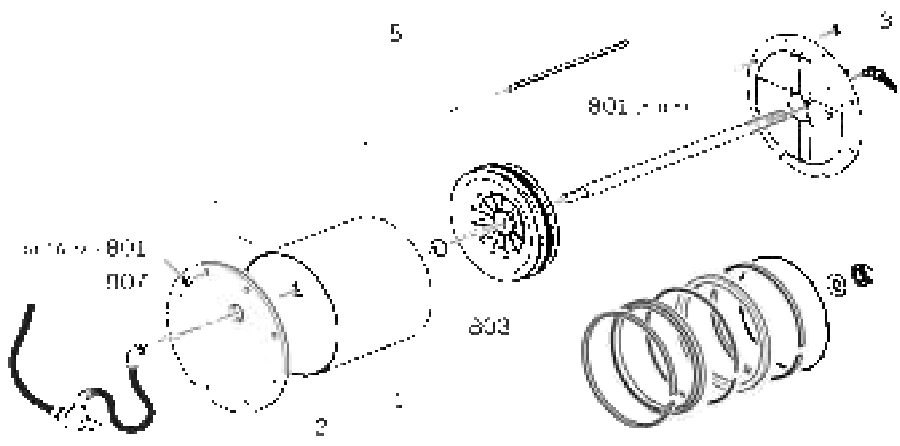
Pos.	Class	Intervall	Customer	Partnumber	IDENTIFICAZIONE (it)	BEZEICHNUNG (de)	Drawing
					IDENTIFICATION (en)	IDENTIFICACION (es)	
					Comment (en)		
801	①	-	-	1695106774	Serie Parti	Teilesatz	
					Parts Set	Juego De Piezas	
802	①	-	-	1695106775	Serie Parti	Teilesatz	
					Parts Set	Juego De Piezas	
803	●	-	X	1695041231	Set Di Guarnizioni	Dichtungssatz	
					Seal Kit	Juego De Juntas	
804	①	-	-	1695106777	Serie Parti	Teilesatz	
					Parts Set	Juego De Piezas	
805	①	-	-	1695106780	Serie Parti	Teilesatz	
					Parts Set	Juego De Piezas	
806	●	-	-	1695106782	Serie Parti	Teilesatz	
					Parts Set	Juego De Piezas	
807	○	-	-	1695108679	Valvola Di Scarico	Ablussventil	
					Drain Valve	Valvula De Purgado	

Pos.	Class	Intervall	Customer	Partnumber	IDENTIFICAZIONE (it)	BEZEICHNUNG (de)	Drawing
					IDENTIFICATION (en)	IDENTIFICACION (es)	
					Comment (en)		
1	①	-	-	1695102051	Cilindro Pneumatico	PN-Zylinder	
					Compressed-Air Cylinder	Cilindro Para Aire A Pr	
2	●	-	-	1695001085	Flangia cilindro pneumatico	Zylinderflansch	
					Cylinder Flange	Brida Para Cilindros	
3	●	-	-	1695001082	Modulo Cilindro	Zylinderbaueinheit	
					Cylinder Assembly Unit	Unidad Constr. Cilindro	
4	①	-	-	1695001083	Copertura	Abdeckung	
					Cover	Cubierta	
5	●	-	-	1695106645	Molla	Feder	
					Spring	Resorte	
6	①	-	-	1695102059	Pala	Schaufel	
					Shovel	Pala	
7	①	-	-	1695102228	Lamiera	Blech	
					Plate	Chapa	
8	①	-	-	1695102067	Copertura di plastica	Kunststoffabdeckung	
					plastic covering	cubierta de plástico	
9	●	-	X	1695041303	Vite Di Regolazione	Stellschraube	
					Adjusting Screw	Tornillo Regulador	
10	●	-	-	1695100297	Rondella	Reduzierscheibe	
					Reducer Shim	Arandela De Reduccion	





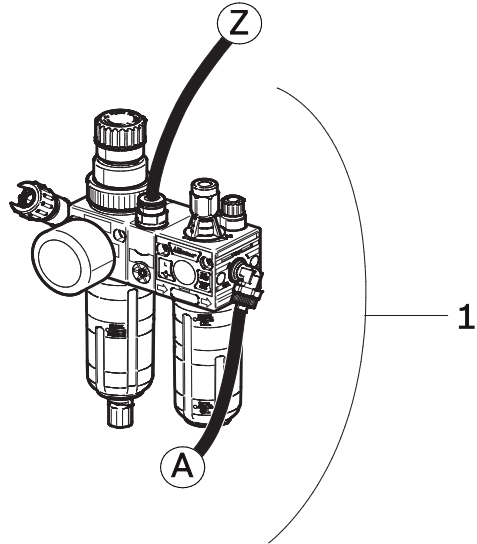

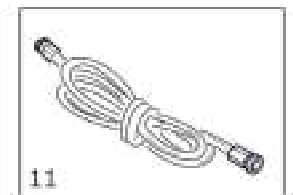
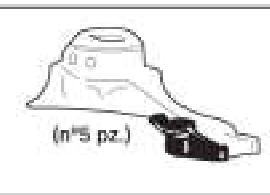
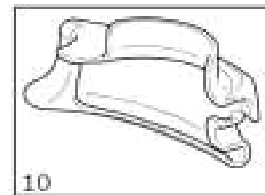
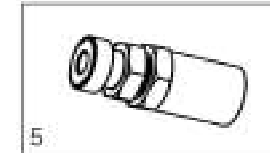
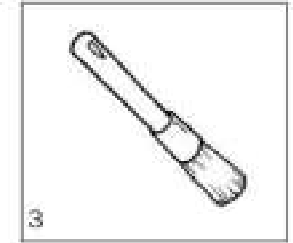
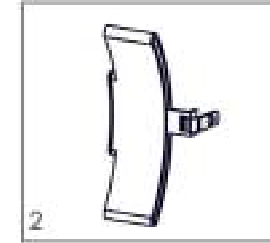
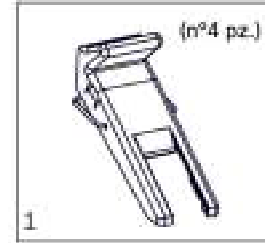

Pos.	Class	Intervall	Customer	Partnumber	IDENTIFICAZIONE (it)	BEZEICHNUNG (de)	Drawing
					IDENTIFICATION (en)	IDENTIFICACION (es)	
					Comment (en)		
11	●	-	-	1695001229	Molla	Feder	
					Spring	Resorte	
801	●	-	-	1695102863	Set Di Ricambi	Ersatzteilsortiment	
					Spares Set	Surtido De Piezas De Rec	
802	●	-	-	1695102864	Set Di Ricambi	Ersatzteilsortiment	
					Spares Set	Surtido De Piezas De Rec	
803	●	-	-	1695102865	Set Di Ricambi	Ersatzteilsortiment	
					Spares Set	Surtido De Piezas De Rec	
804	●	-	-	1695102906	Set Di Ricambi	Ersatzteilsortiment	
					Spares Set	Surtido De Piezas De Rec	
805	●	-	-	1695102911	Set Di Ricambi	Ersatzteilsortiment	
					Spares Set	Surtido De Piezas De Rec	
806	●	-	-	1695106780	Serie Parti	Teilesatz	
					Parts Set	Juego De Piezas	
807	●	-	-	1695106777	Serie Parti	Teilesatz	
					Parts Set	Juego De Piezas	
808	●	-	-	1695106774	Serie Parti	Teilesatz	
					Parts Set	Juego De Piezas	
809	●	-	X	1695041231	Set Di Guarnizioni	Dichtungssatz	
					Seal Kit	Juego De Juntas	

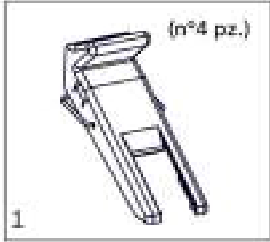
Pos.	Class	Intervall	Customer	Partnumber	IDENTIFICAZIONE (it)	BEZEICHNUNG (de)	Drawing	
					IDENTIFICATION (en)	IDENTIFICACION (es)		
					Comment (en)			
810	1	-	-	1695106775	Serie Parti	Teilesatz		
					Parts Set	Juego De Piezas		

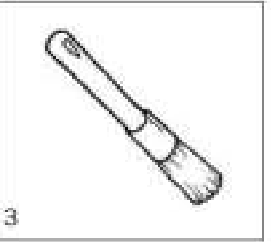
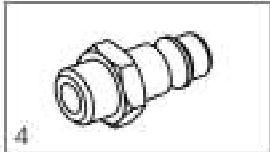
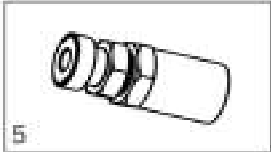
Pos.	Class	Intervall	Customer	Partnumber	IDENTIFICAZIONE (it)	BEZEICHNUNG (de)	Drawing	
					IDENTIFICATION (en)	IDENTIFICACION (es)		
					Comment (en)			
1	●	-	-	1695101497	Filtro Pneumatico	Luftfilter		
					Air Filter	Filtro De Aire		

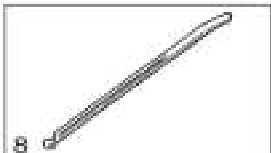
Pos.	Class	Intervall	Customer	Partnumber	IDENTIFICAZIONE (it)	BEZEICHNUNG (de)	Drawing
					IDENTIFICATION (en)	IDENTIFICACION (es)	
					Comment (en)		
1	●	-	-	1695102148	SET ACCESSORIO	Zubehör-Sortiment	
					Accessory Assortment	Surtido De Accesorios	
2	●	-	x	1695106152	Copertura di plastica	Kunststoffabdeckung	
					plastic covering	cubierta de plástico	
3	●	-	x	1695100123	Pennello	Pinsel	
					Brush	Brocha	
4	●	-	X	1695042398	Raccordo	Anschlusstück	
					Connecting Piece	Racor	
5	●	-	-	1695040325	Raccordo	Anschlusstück	
					Connecting Piece	Racor	
6	●	-	-	1695040162	Raccordo	Anschlusstutzen	
					Fitting	Racor De Empalme	
7	●	-	x	1695102683	Leva Di Montaggio	Montierhebel	
					Assembly Lever	Palanca De Montaje	
8	●	-	-	1695108668	Leva D'espulsione	Auswerfhebel	
					Ejection Lever	Palanca Expulsora	
9	●	-	X	1695042877	Pistola di gonfiaggio	Druckluftpistole	
					Air Gun	pistola de aire compr.	

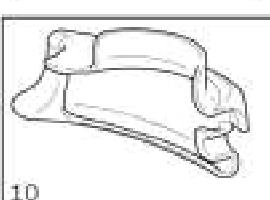

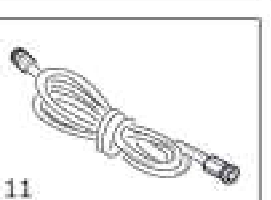
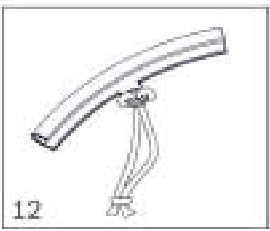
Pos.	Class	Intervall	Customer	Partnumber	IDENTIFICAZIONE (it)	BEZEICHNUNG (de)	Drawing
					IDENTIFICATION (en)	IDENTIFICACION (es)	
					Comment (en)		
10	●	-	-	1695101503	SET ACCESSORIO	Zubehör-Sortiment	
					Accessory Assortment	Surtido De Accesorios	
11	●	-	X	1695104542	Tubo Flessibile	Schlauch	
					Hose	Manguera	
12	●	-	-	1695105191	Accessorio	Zubehörteil	
					Accessory Part	Accesorio	
							
							
							
							
							
							
							
							
							
							

Sicam

History

Date	Product	Editor	Modification
2019-02-13	FALCO EVO 624 S	Bove	New product



Sicam S.r.l.
Tyre Equipments & Tools
Via G. Corradini, 1
42015 Correggio (RE)
ITALY
www.sicam.it

1 695 108 809 - 2019-02-13