

# SBM WAVE 5 LCD AWP



it Lista dei ricambi      de Ersatzteilliste  
en Spare part list      es Listas de piezas de recambio

Class	----- de -----	----- en -----	----- fr -----	----- es -----	----- it -----
●	<b>Verschleißteil:</b> <b>Definition:</b> Zu erwartende Lebensdauer des Teiles ist kleiner als die zu erwartende Lebensdauer des Produktes!  - Bei Ausfall nicht mehr funktionsfähig oder sicherer Einsatz des Produktes nicht mehr gewährleistet - Verminderte Gewährleistung - Wir empfehlen, diese Ersatzteile im lokalem Lager zu bevorraten.  Hinweis: Der Verschleiß und das Wartungsintervall sind abhängig von: - der Einsatzzeit - Art und Häufigkeit der Verwendung - Alter der Maschine	<b>Wearing part:</b> <b>Definition:</b> The expected lifetime of the part is shorter than the expected lifetime of the product!  - In the event of failure, no longer functional or safe use of product no longer guaranteed - Reduced warranty - We recommend stocking these replacement parts in the local warehouse.  Note: Wear and the maintenance interval depend on: - Usage time - Nature and frequency of use - Age of machine	<b>Pièce d'usure :</b> <b>Définition :</b> La durée de vie prévisible de la pièce est inférieure à la durée de vie prévisible du produit !  - Plus en ordre de marche en cas de panne ou utilisation sûre du produit plus garantie - Garantie réduite - Nous conseillons d'avoir ces pièces de rechange en réserve dans un entrepôt local.  Remarque : L'usure et l'intervalle d'entretien dépendent des facteurs suivants : - durée d'utilisation - nature et fréquence de l'utilisation - âge de la machine	<b>Pieza de desgaste:</b> <b>Definición:</b> La vida útil esperada de la pieza es menor que la vida útil esperada del producto.  - En caso de avería ya no está en condiciones de funcionar o el uso seguro del producto ya no se garantiza - Garantía reducida - Se recomienda almacenar esas piezas de recambio en un almacén local.  Nota: El desgaste y el intervalo de mantenimiento dependen: - del tiempo de servicio - del tipo y frecuencia de uso - de la edad de la máquina	<b>Parte soggetta a usura:</b> <b>Definizione:</b> Il ciclo di vita prevedibile del componente è inferiore al ciclo di vita prevedibile del prodotto.  - In caso di avaria il prodotto non è più in grado di funzionare oppure non ne è più garantita la sicurezza d'impiego - Garanzia ridotta - Consigliamo di tenere una scorta di questi ricambi nel magazzino ocale.  Avvertenza: l'usura e l'intervallo di manutenzione dipendono da: - tempo operativo - tipo e frequenza dell'impiego - età della macchina
⊙	<b>Funktionsteil:</b> <b>Definition:</b> Die zu erwartende Lebensdauer des Teiles ist gleich oder größer als die zu erwartende Lebensdauer des Produktes!  - Bei Ausfall nicht mehr funktionsfähig oder sicherer Einsatz des Produktes nicht mehr gewährleistet - Standard Gewährleistung - Wir empfehlen, diese Ersatzteile im lokalem Lager zu bevorraten.	<b>Function part:</b> <b>Definition:</b> The expected lifetime of the part is the same as or longer than the expected lifetime of the product!  - In the event of failure, no longer functional or safe use of product no longer guaranteed - Standard warranty - We recommend stocking these replacement parts in the local warehouse.	<b>Pièce fonctionnelle :</b> <b>Définition :</b> La durée de vie prévisible de la pièce est égale ou supérieure à la durée de vie prévisible du produit !  - Plus en ordre de marche en cas de panne ou utilisation sûre du produit plus garantie - Garantie standard - Nous conseillons d'avoir ces pièces de rechange en réserve dans un entrepôt local.	<b>Pieza funcional:</b> <b>Definición:</b> La vida útil esperada de la pieza es igual o mayor que la vida útil esperada del producto.  - En caso de avería ya no está en ndiciones de funcionar o el uso seguro del producto ya no se garantiza - Garantía estándar - Se recomienda almacenar esas piezas de recambio en un almacén local.	<b>Parte funzionale:</b> <b>Definizione:</b> Il ciclo di vita prevedibile del componente è uguale o superiore al ciclo di vita prevedibile del prodotto.  - In caso di avaria il prodotto non è più in grado di funzionare oppure non ne è più garantita la sicurezza d'impiego - Garanzia standard - Consigliamo di tenere una scorta di questi ricambi nel magazzino locale.
○	<b>Nicht-Funktionsteil:</b> <b>Definition:</b> Die zu erwartende Lebensdauer des Teiles ist gleich oder größer als die zu erwartende Lebensdauer des Produktes!  - Bei Ausfall weiterhin funktionsfähig und ein sicherer Einsatz des Produktes ist gewährleistet - Standard Gewährleistung - Wir empfehlen, diese Ersatzteile bei einem Bedarf über das Zentrallager zu bestellen.	<b>Non-function part:</b> <b>Definition:</b> The expected lifetime of the part is the same as or longer than the expected lifetime of the product!  - In the event of failure, still functional and safe use of the product is guaranteed - Standard warranty - We recommend ordering these replacement parts as required via the central warehouse.	<b>Pièce non fonctionnelle :</b> <b>Définition :</b> La durée de vie prévisible de la pièce est égale ou supérieure à la durée de vie prévisible du produit !  - Toujours en ordre de marche en cas de panne et utilisation sûre du produit garantie - Garantie standard - Nous recommandons de commander ces pièces de rechange au besoin par le biais de l'entrepôt central.	<b>Pieza no funcional:</b> <b>Definición:</b> La vida útil esperada de la pieza es igual o mayor que la vida útil esperada del producto.  - En caso de avería aún en condiciones de funcionar y el uso seguro del producto se garantiza - Garantía estándar - Se recomienda pedir esas piezas de recambio al almacén central, en caso de necesidad.	<b>Parte non funzionale:</b> <b>Definizione:</b> Il ciclo di vita prevedibile del componente è uguale o superiore al ciclo di vita prevedibile del prodotto.  - In caso di avaria il prodotto continua ad essere in grado di funzionare e ne rimane garantita la sicurezza d'impiego - Garanzia standard - Consigliamo di ordinare questi ricambi in caso di necessità attraverso il magazzino centrale.

Intervall	Wartungsintervall des Verschleißteiles	Maintenance intervall for wearing part	Intervalle d'entretien de la pièce d'usure	Intervalo de mantenimiento de la pieza de desgaste	Intervallo di manutenzione della parte soggetta a usura
h	Stunden	hours	heures	Horas	ore
d	Tage	days	jours	Días	giorni
m	Monate	month	mois	Meses	mesi
cy	Zyklen	cycles	cycles	Ciclos	cicli
-	ohne definiertes Wartungsintervall	No defined maintenance interval	pas d'intervalle d'entretien défini	Sin intervalo de mantenimiento definido	senza intervallo di manutenzione definito

Customer	Austausch des Teiles durch den Kunden (Werkstatt)	Replacement of part by customer (workshop)	Remplacement de la pièce par le client (atelier)	Sustitución de la pieza por el cliente (taller)	La sostituzione del componente da parte del cliente (officina)
-	ist nicht erlaubt.	Not permissible.	pas autorisé	no está permitida.	non è ammessa.
x	ist erlaubt (Diese Ersatzteile sind auch in der Betriebsanleitung aufgeführt)	Permissible (these replacement parts are also listed in the operating instructions)	autorisé (ces pièces de rechange sont également indiquées dans la notice d'utilisation)	está permitida (estas piezas de recambio también se indican en las instrucciones de servicio).	è ammessa (questi ricambi sono riportati anche nelle istruzioni d'uso)

Part-number	Bestellnummer des Ersatzteiles oder Verweis auf ein Standardteil	Order number of replacement part or reference to standard part	Référence de commande de la pièce de rechange ou signalement de pièce normalisée	Número de pedido de la pieza de recambio o nota sobre la pieza normalizada	Codice di ordinazione del ricambio o avvertenza sul componente unificato
Normpart	<b>Normteil:</b> Ersatzteile, die normalerweise über unterschiedliche Kanäle bezogen werden können wie z. B. Schrauben, Muttern, O-Ringe, Tintenpatronen. Alle 3 Ersatzteil-Kategorien (siehe Class) sind möglich	<b>Normpart (Standard part):</b> Replacement parts which can normally be obtained through various channels e.g. bolts, nuts, O-rings, ink cartridges. All 3 replacement part categories (refer to Class) are possible	<b>Pièce normalisée :</b> Pièces de rechange qui peuvent normalement être obtenues par le biais de différents canaux, par ex. les vis, écrous, joints toriques, cartouches d'encre. Les 3 catégories de pièces de rechange (voir Class) sont possibles	<b>Pieza normalizada:</b> Piezas de recambio que se pueden adquirir normalmente a través de diferentes vías, p. ej., tornillos, tuercas, anillos de sección circular, cartuchos de tinta. Las tres categorías de piezas de recambio (véase clase) son posibles.	<b>Parte unificata (componente unificato):</b> Si tratta di ricambi che in genere possono essere acquistati attraverso diversi canali, come ad es. viti, dadi, O-ring, cartucce di inchiostro. Sono possibili tutte e 3 le categorie di ricambi (vedi Class)

SBM WAVE 5 LCD AWP

Bezeichnung Designation Dénomination Designación	Bestellnummer Partnumber Référence Núm.depedido	Gefertigt von Production since fabrication de	Gefertigt bis produced until fabrication fabricación	Ersatzteilkpflicht bis Service part obligation Obligation de pièce de rechange Obligación de disp. de piezas de recambio	Bemerkungen Notes Notes Notas
SBM WAVE 5 LCD AWP	1694302496	feb-19			230V, 1 PH, 50-60 Hz Ral colour 3000 (red) Digital machine Automatic measure width arm Pneumatic locking flange
SBM WAVE 5 LCD AWP (Laser)	1694302500	feb-19			230V, 1 PH, 50-60 Hz Ral colour 3000 (red) Digital machine Automatic measure width arm Laser pointer and light ring Pneumatic locking flange



Pos.	Class	Intervall	Customer	Partnumber	IDENTIFICAZIONE (it)	BEZEICHNUNG (de)	Drawing
					IDENTIFICATION (en)	IDENTIFICACION (es)	
					Comment (en)		
1	●	-	-	1695600888	Pedale	Trittplatte	
					Plate-Type Brake-Pedal	Pedal	
2	○	-	-	1695042777	Microinterruttore	Mikroschalter	
					Microswitch	Microinterruptor	
3	●	-	-	1695001227	Molla	Feder	
					Spring	Resorte	
4	●	-	-	1695600885	Composto saldato	Schweissbaugruppe	
					Welded assembly	Montaje soldado	
4*	●	-	-	1695600886	Ral 3000 (red)		
					Composto saldato	Schweissbaugruppe	
4**	●	-	-	1695600992	Welded assembly	Montaje soldado	
					Ral 7040 (grey)		
4***	●	-	-	1695656884	Composto saldato	Schweissbaugruppe	
					Welded assembly	Montaje soldado	
5	●	-	-	Normpart	Vite bombata esagonale	Innensechsktflachkopfschr	
					Hex Socket Button Screw	Tornillo abombada hex	
801	●	-	-	1695600978	Kit Pezzi Di Ricambio	Ersatzteilsatz	
					Service kit	Juego De Repuestos	

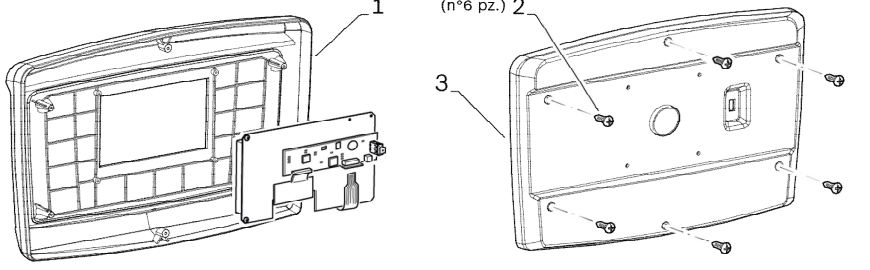
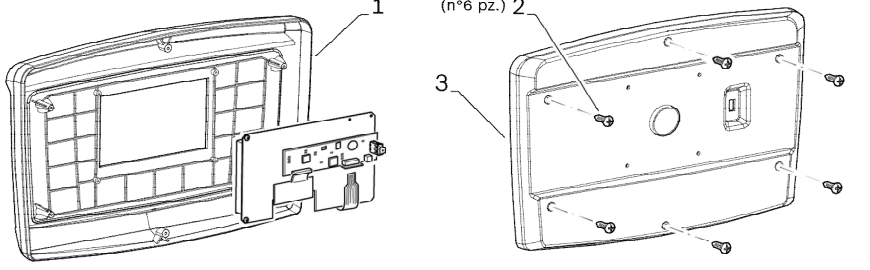
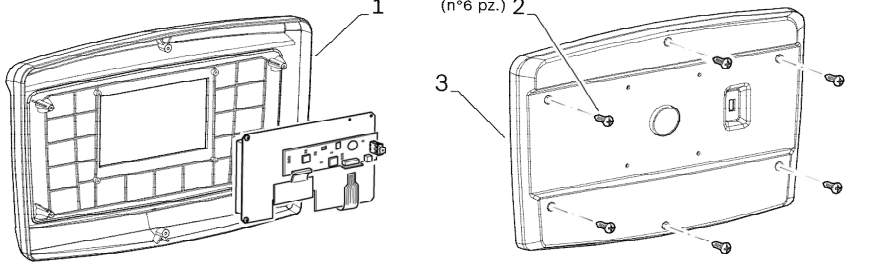
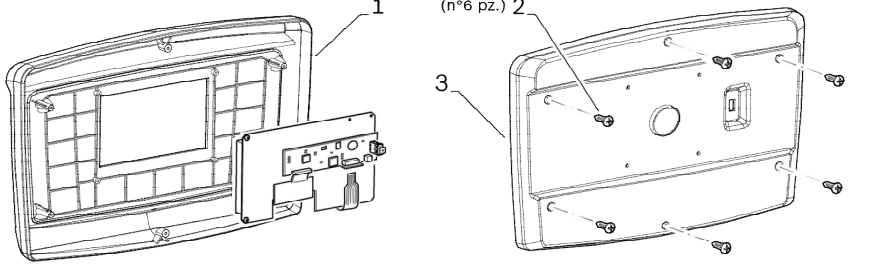
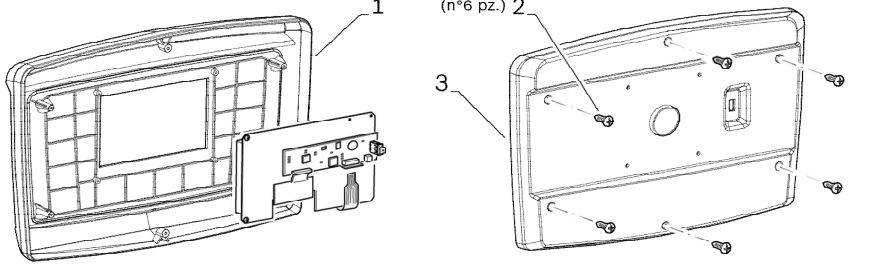
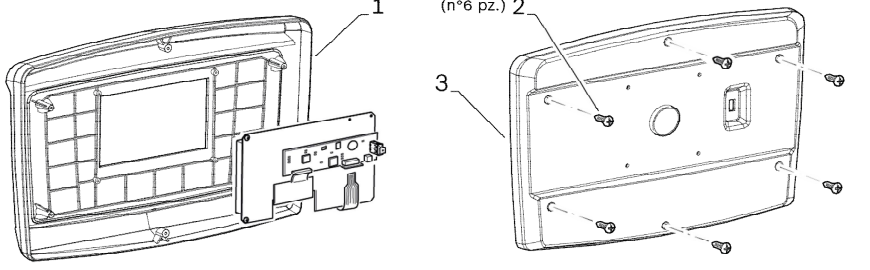
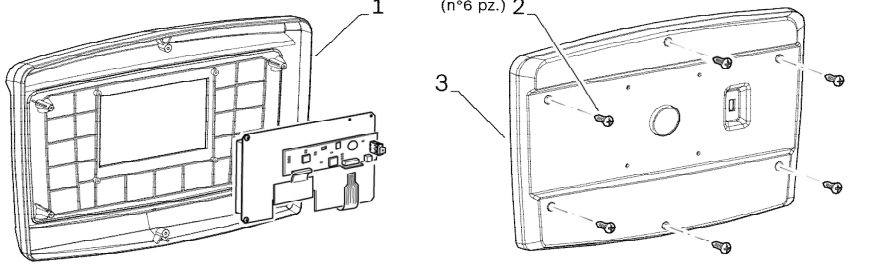
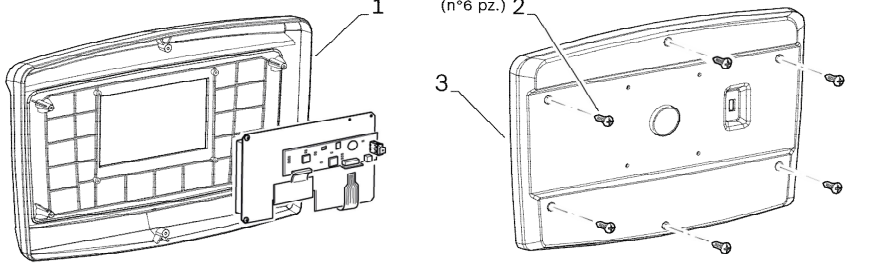
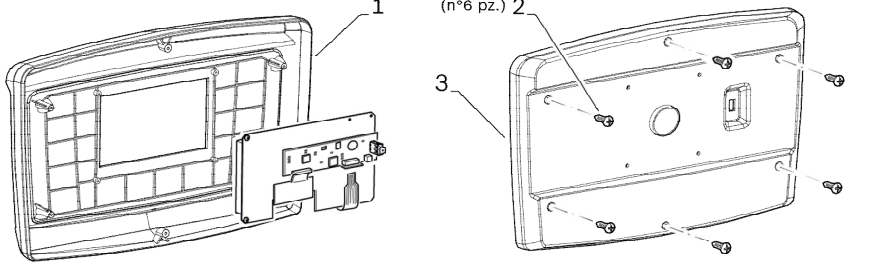
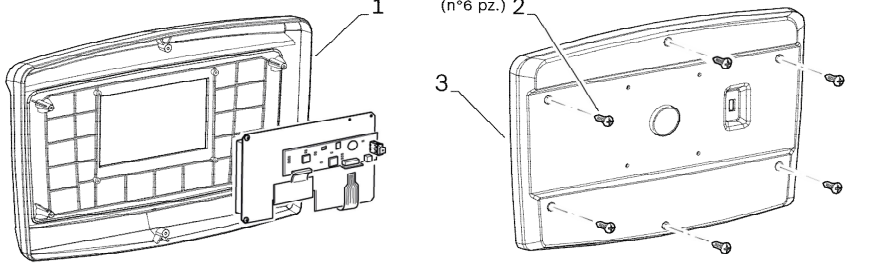
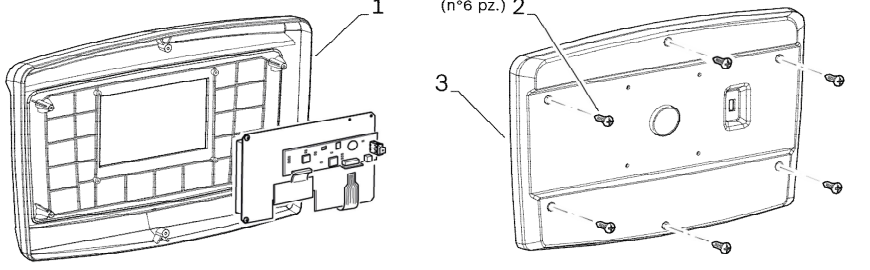
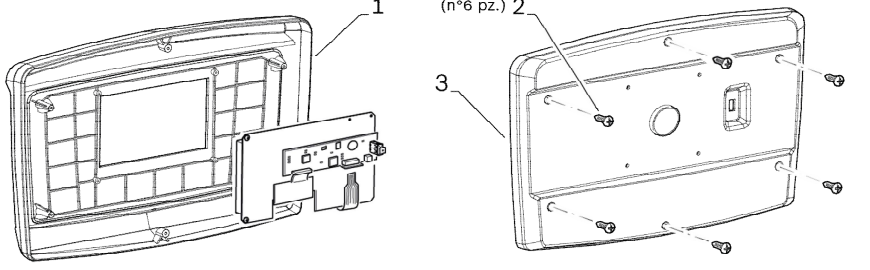
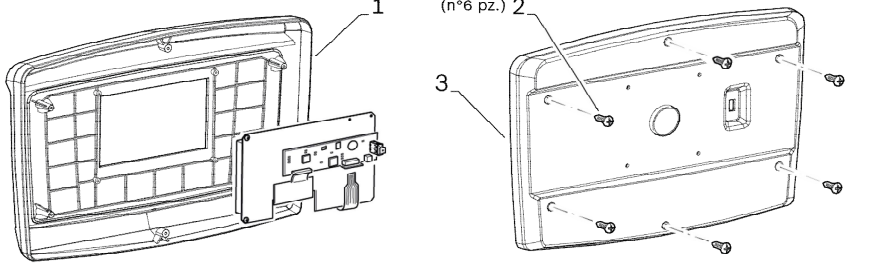
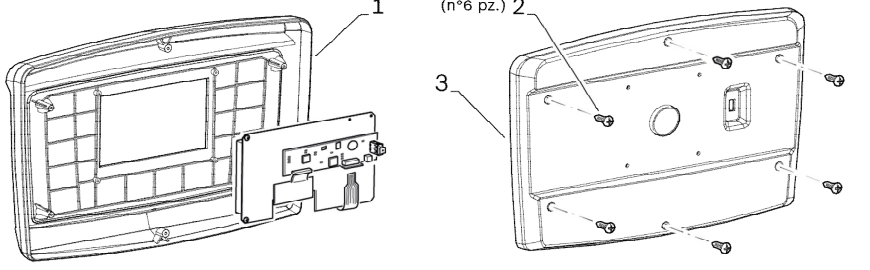
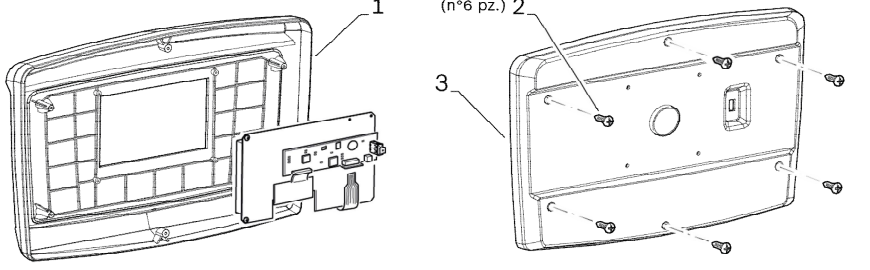
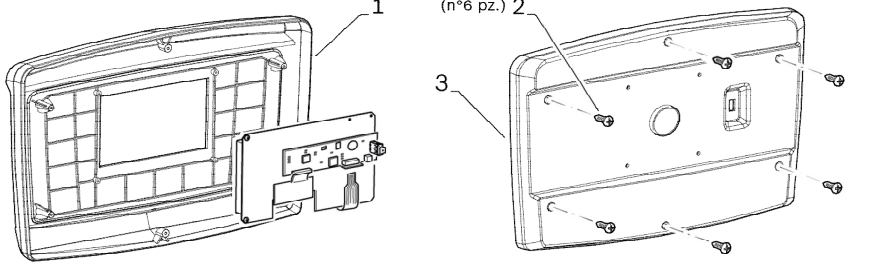
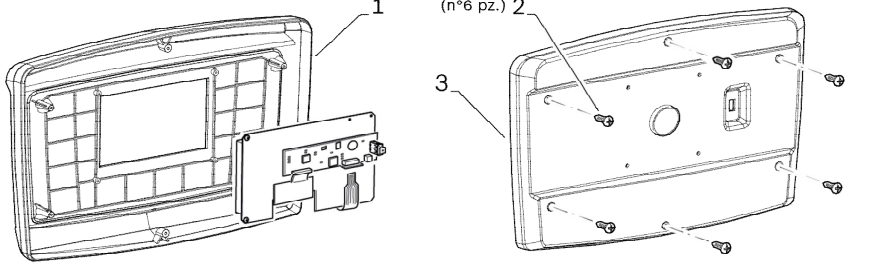
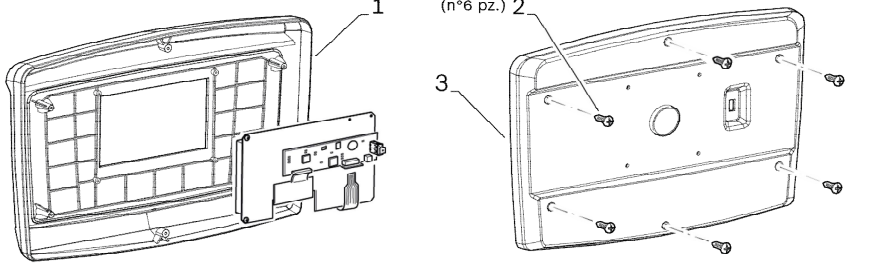
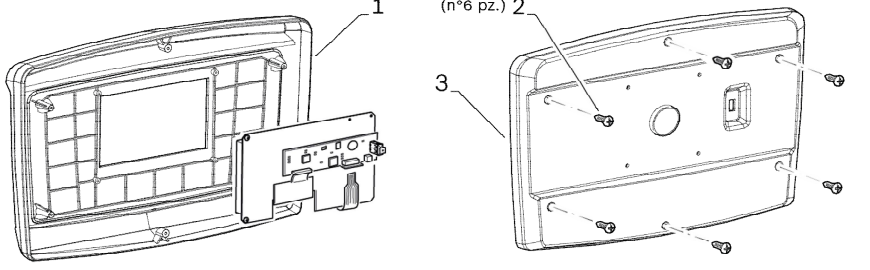
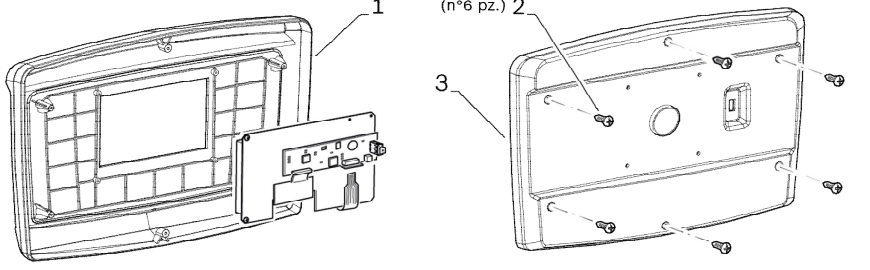
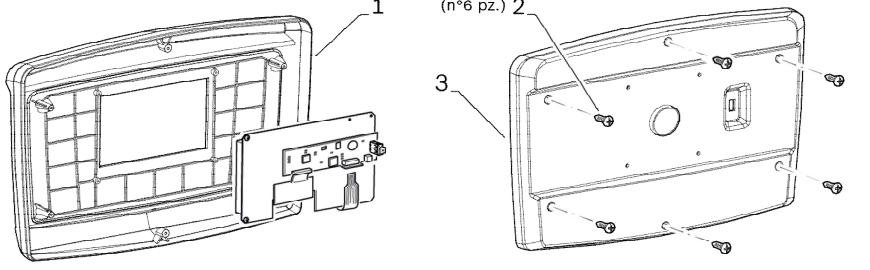
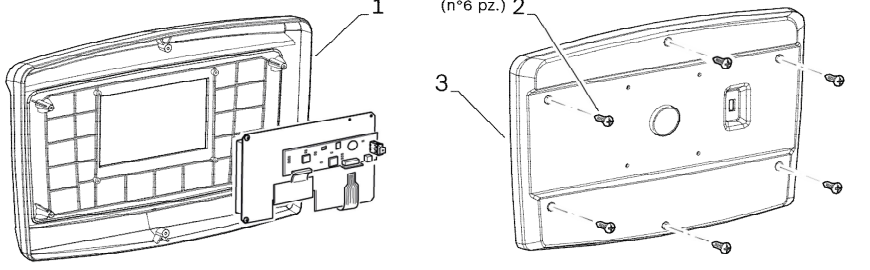
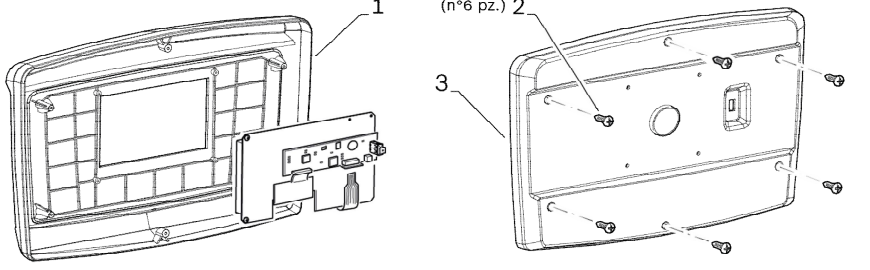
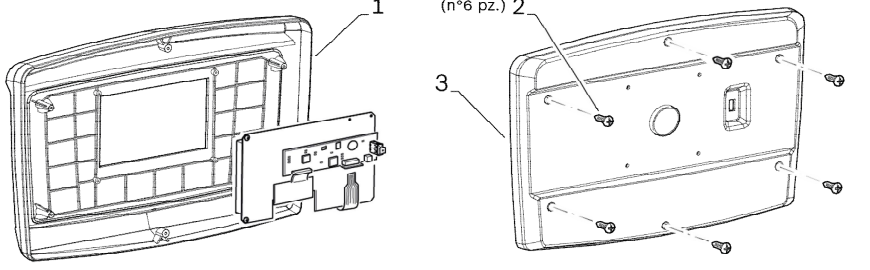
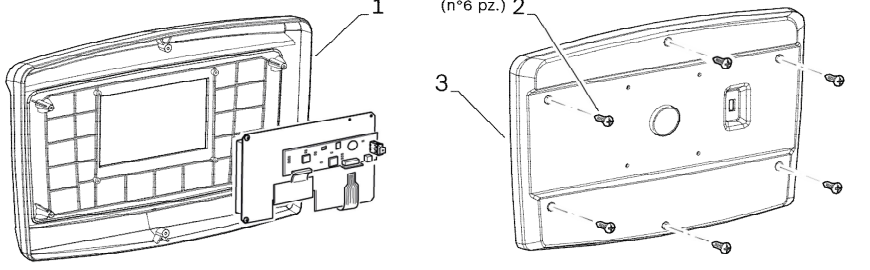
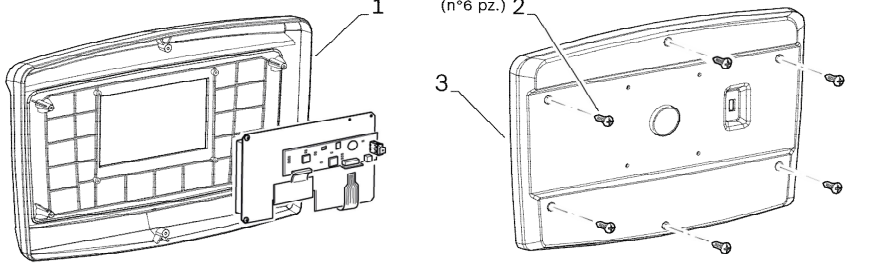
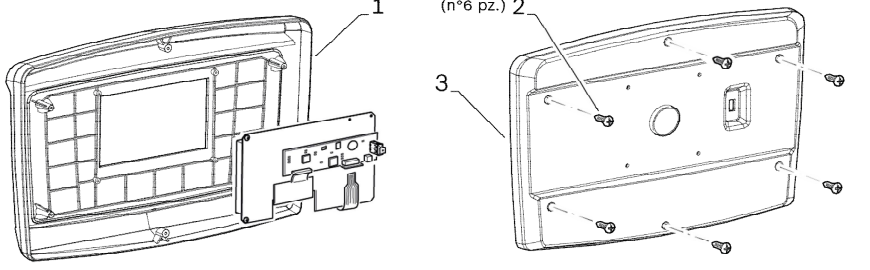
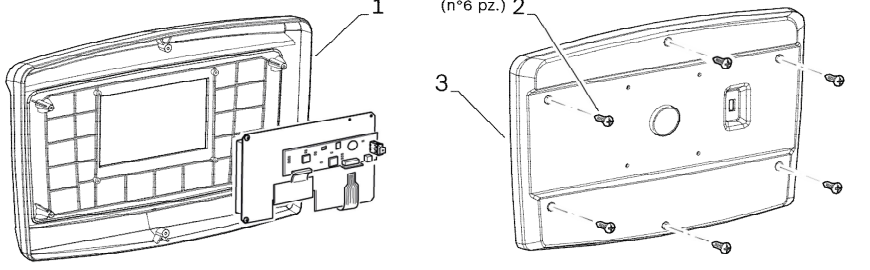
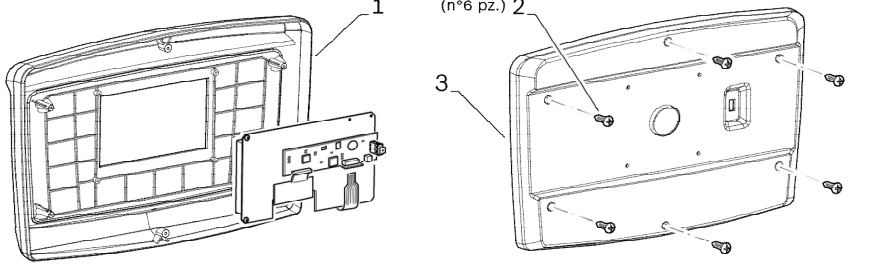
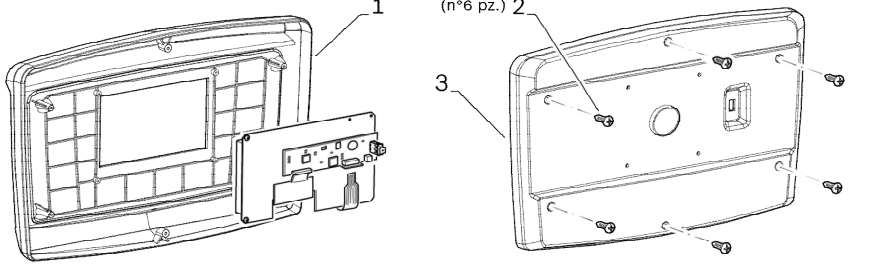
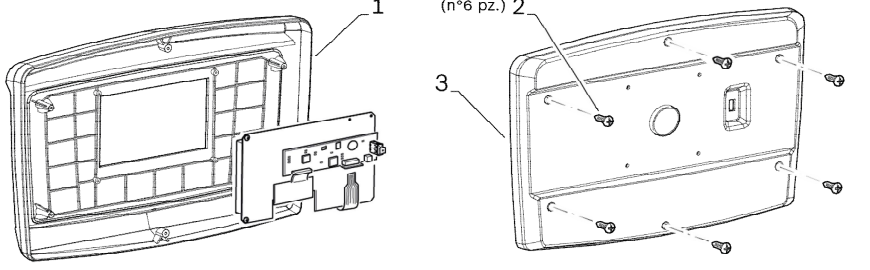
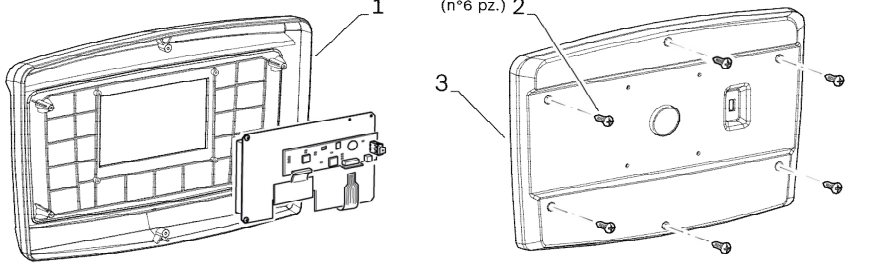
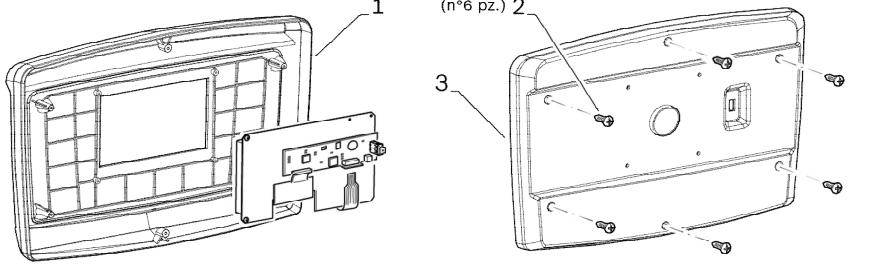
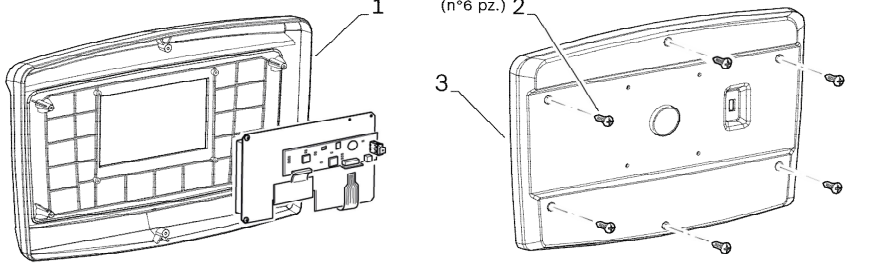
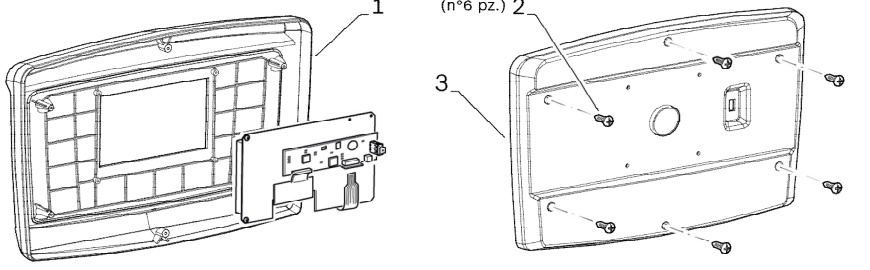
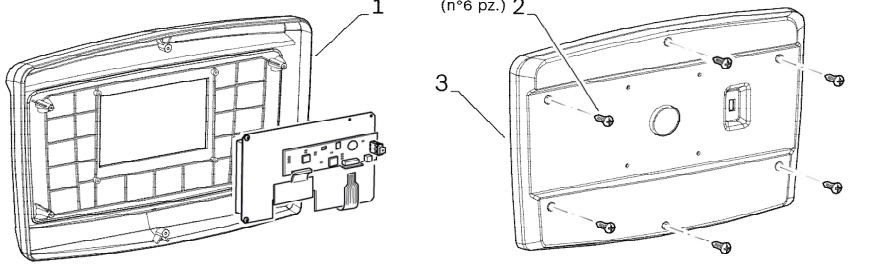
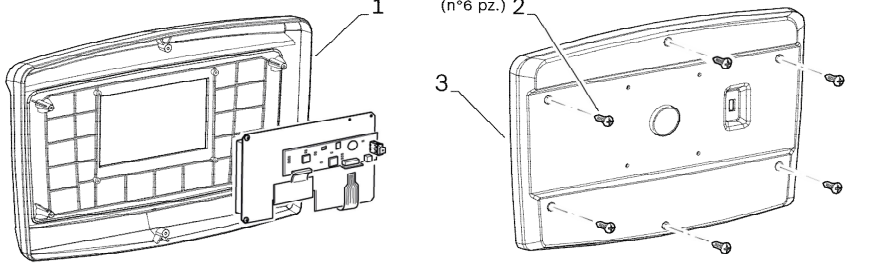
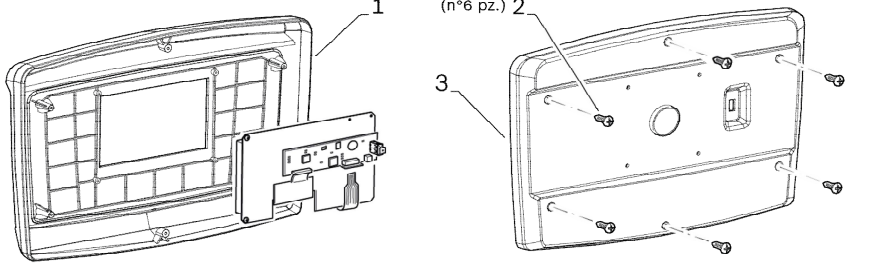
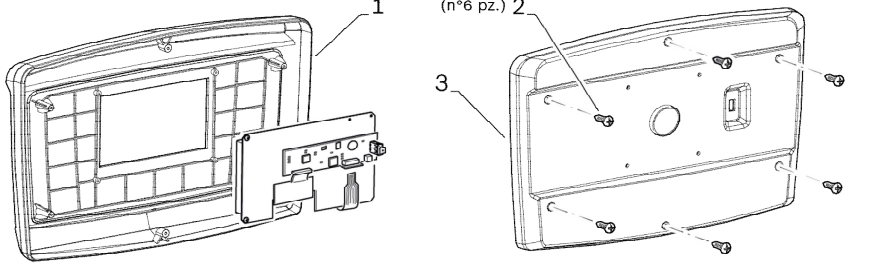
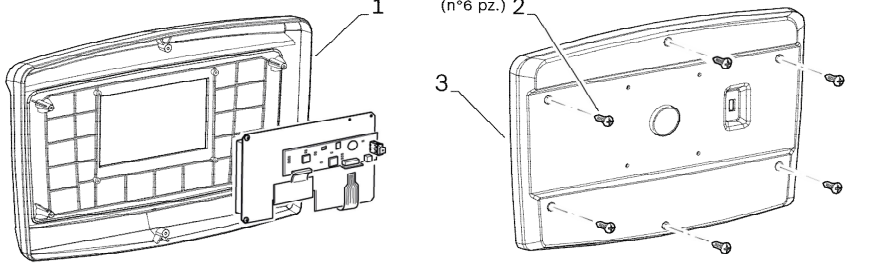
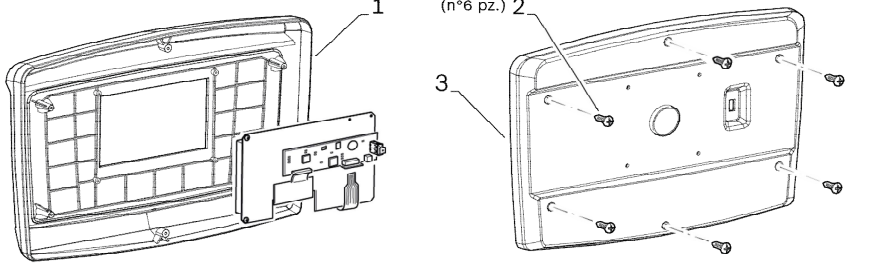
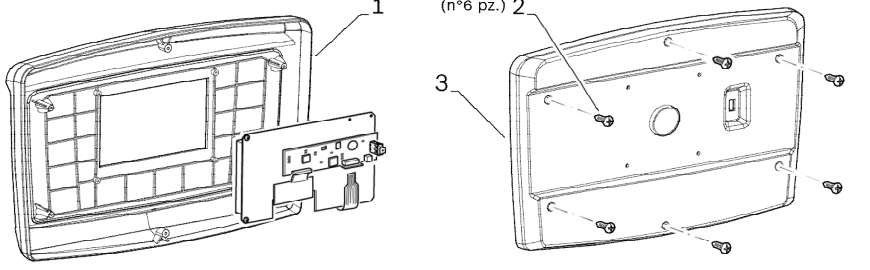
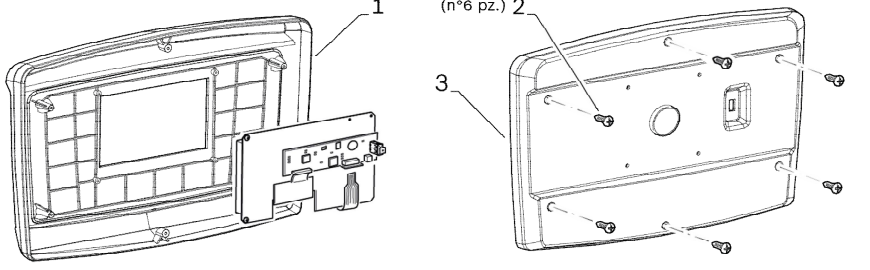
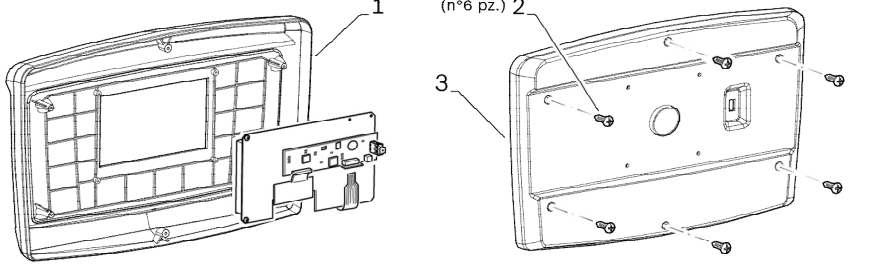
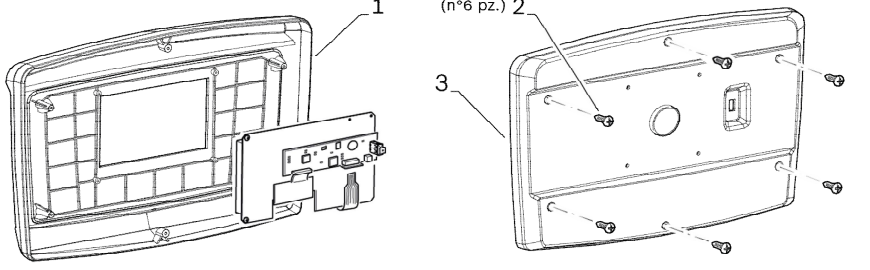
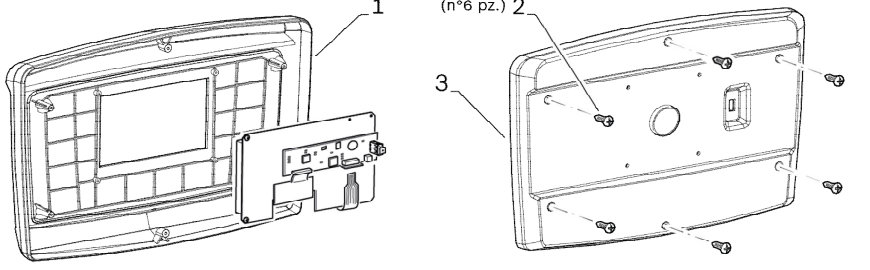
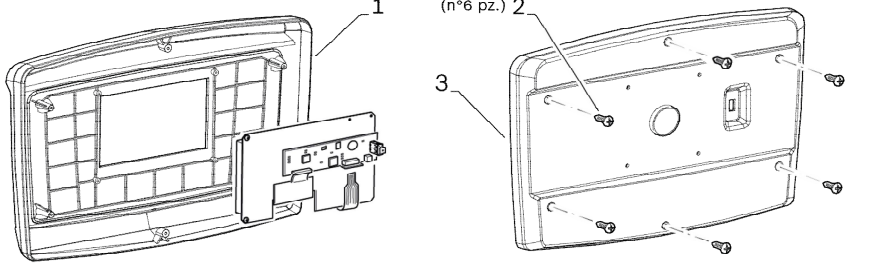
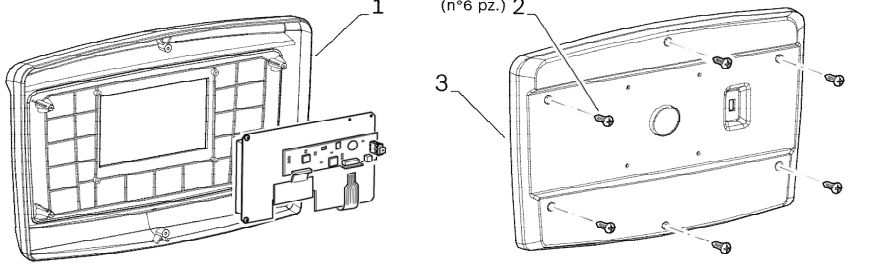
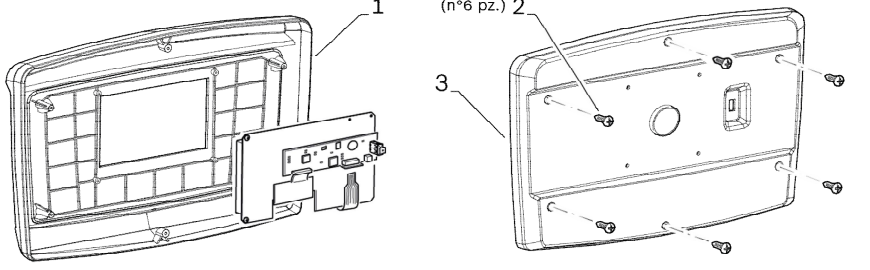
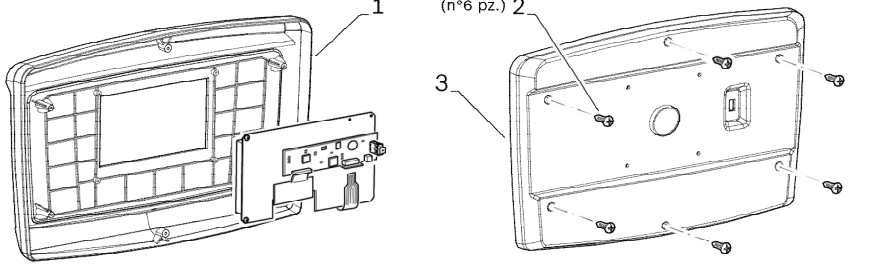
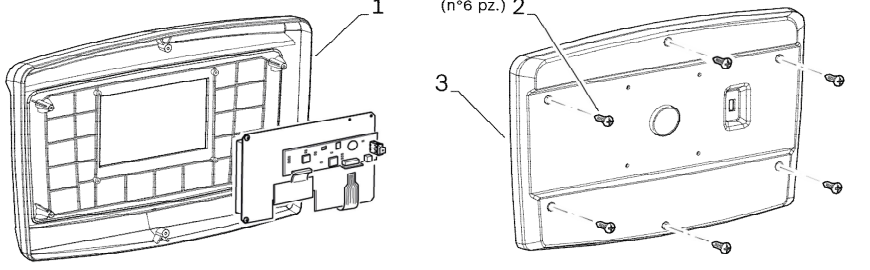
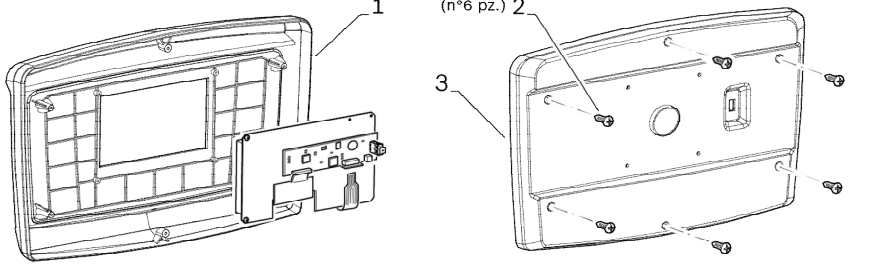
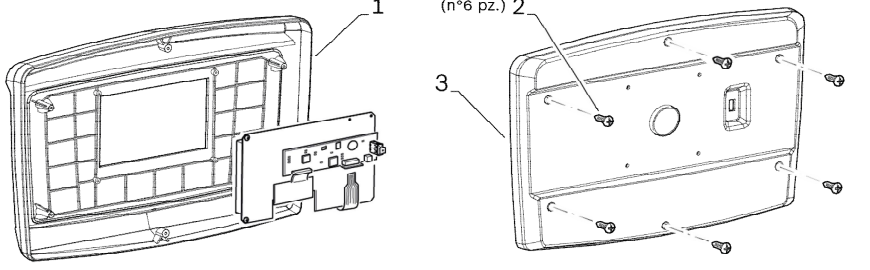
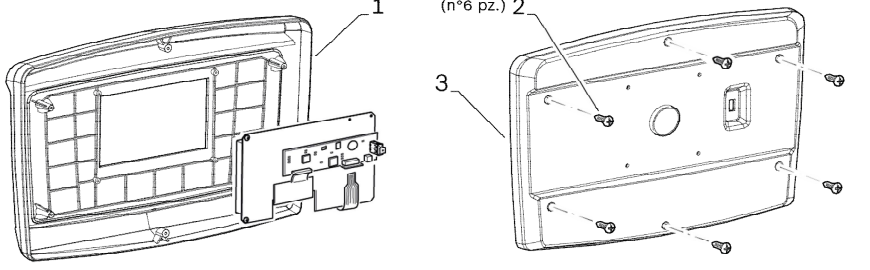
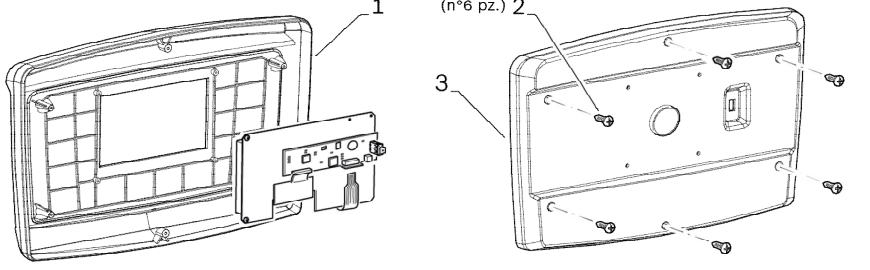
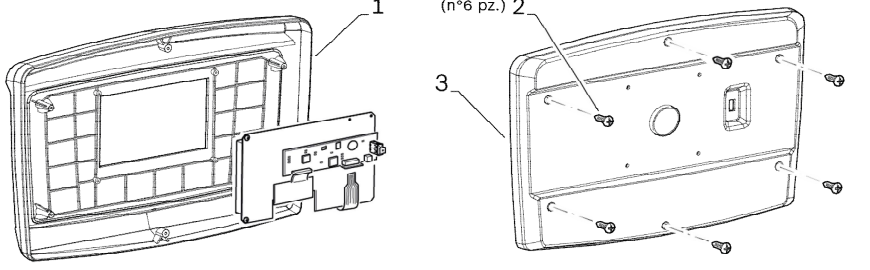
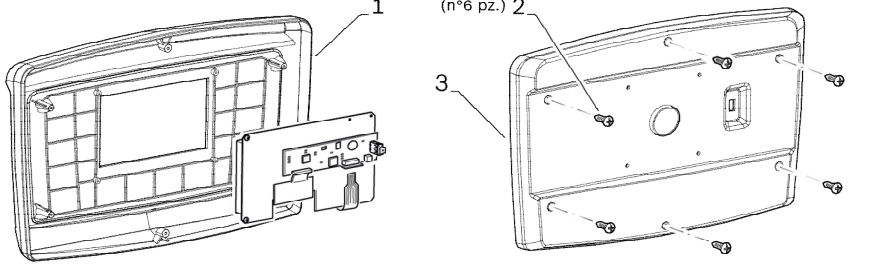
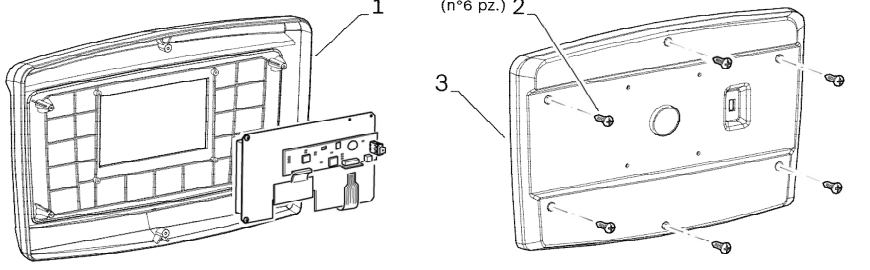
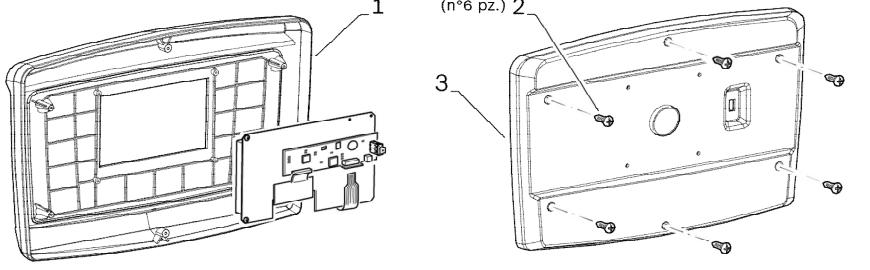
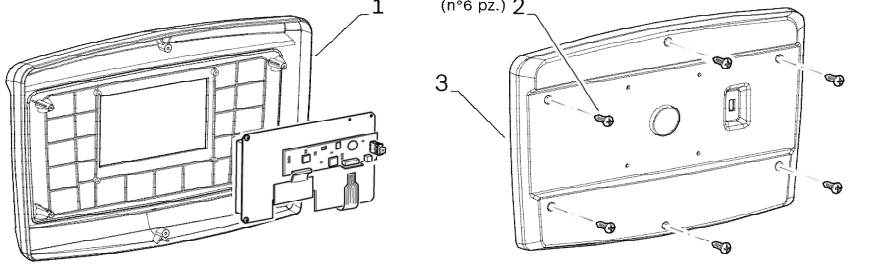
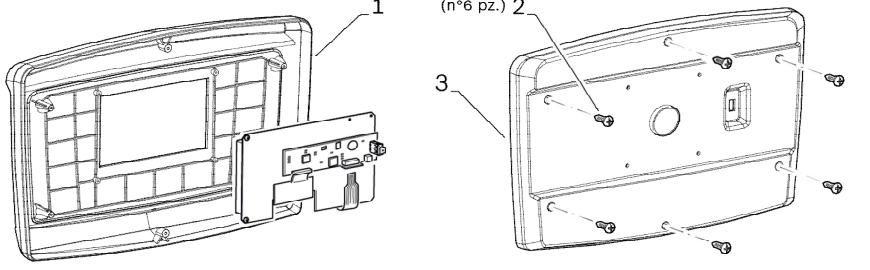
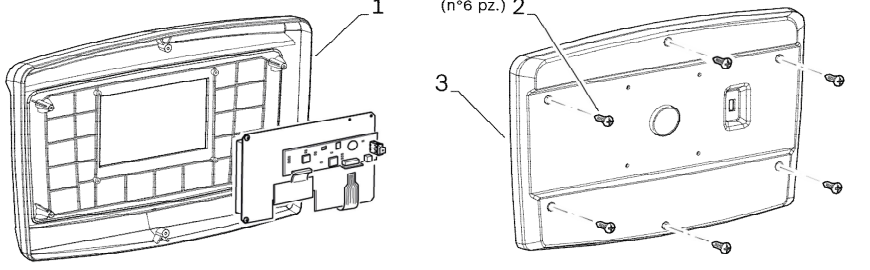
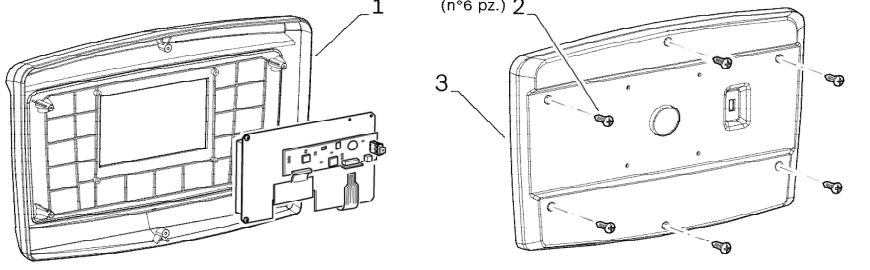
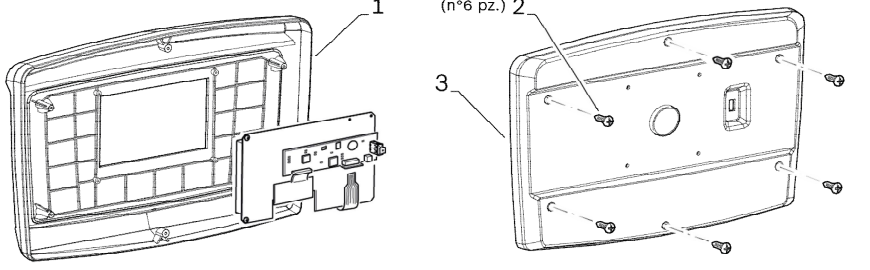
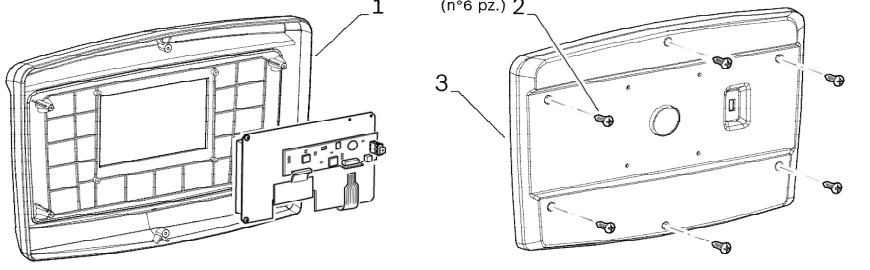
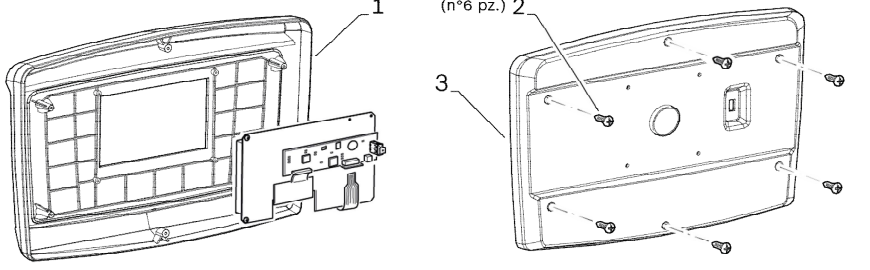
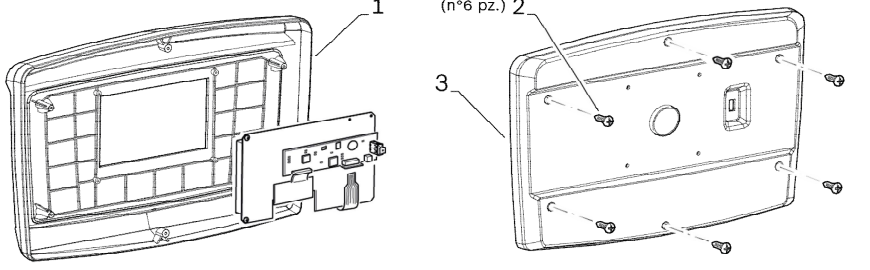
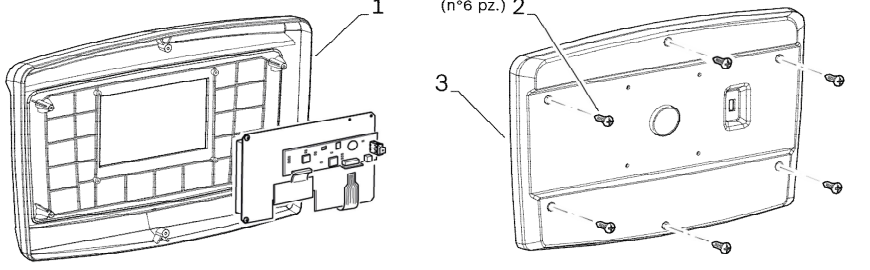
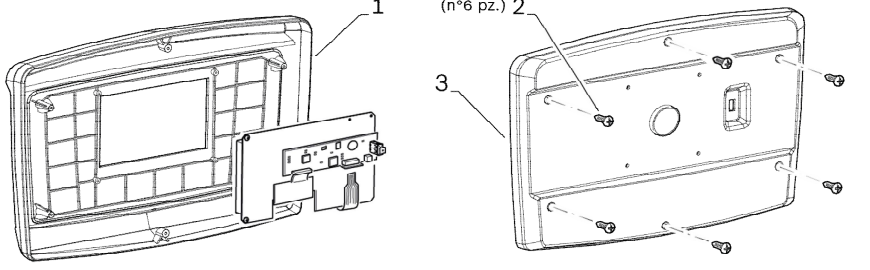
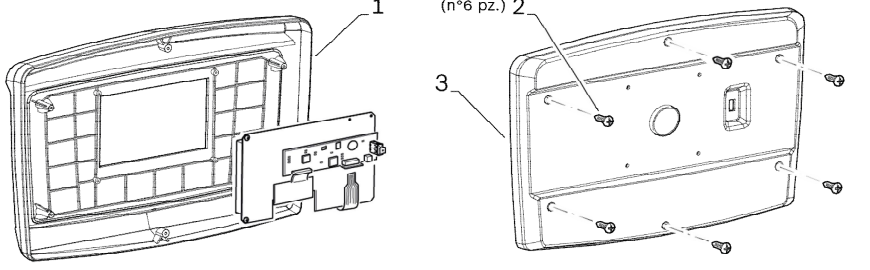
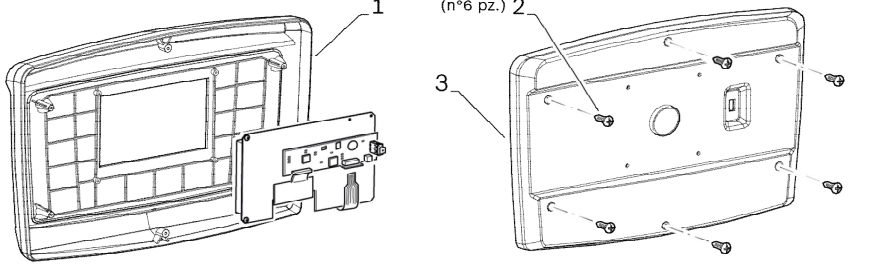
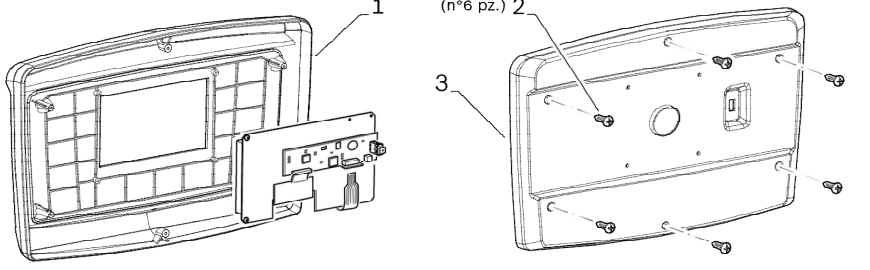
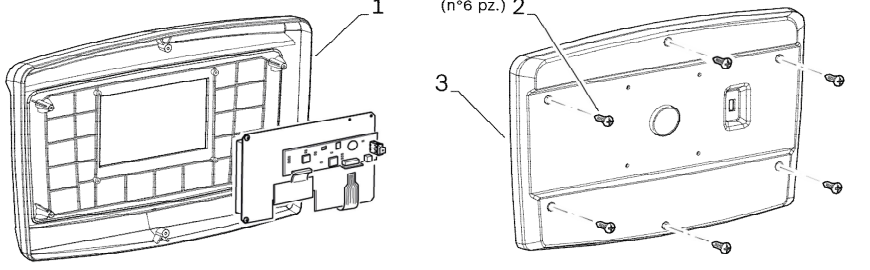
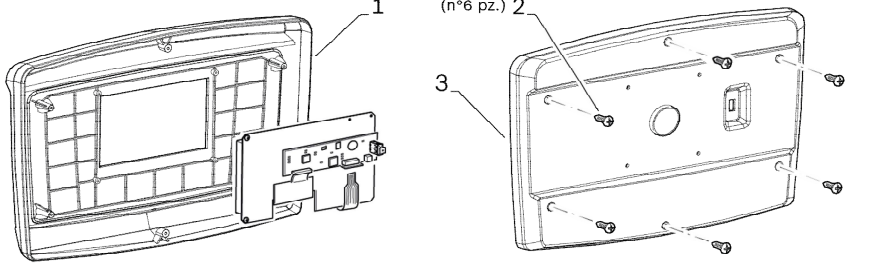
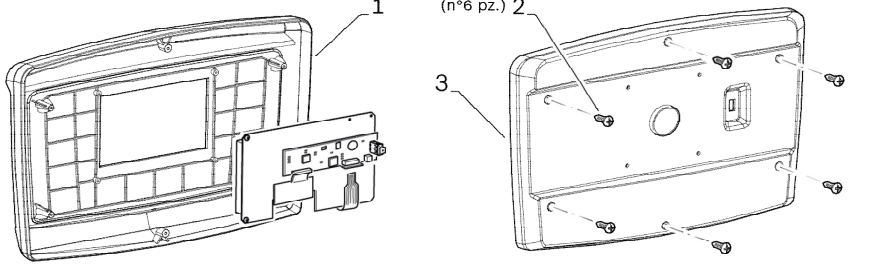
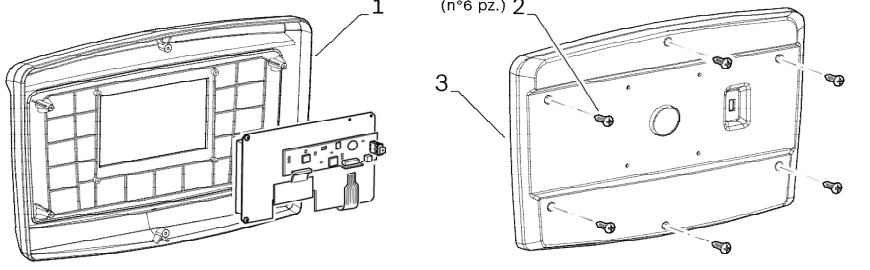
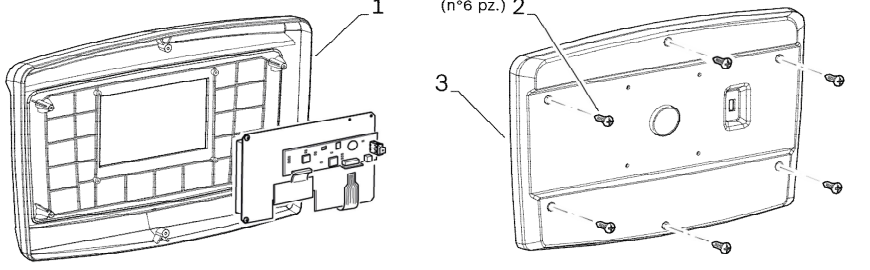
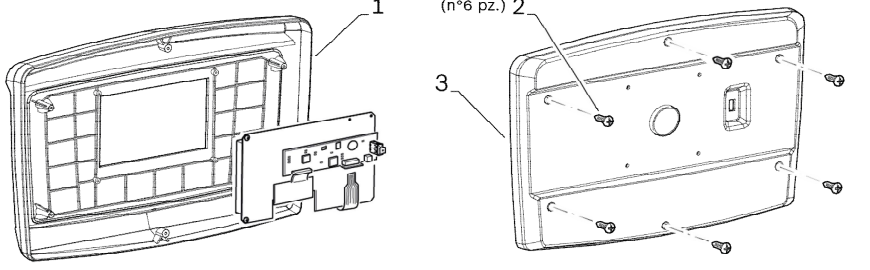
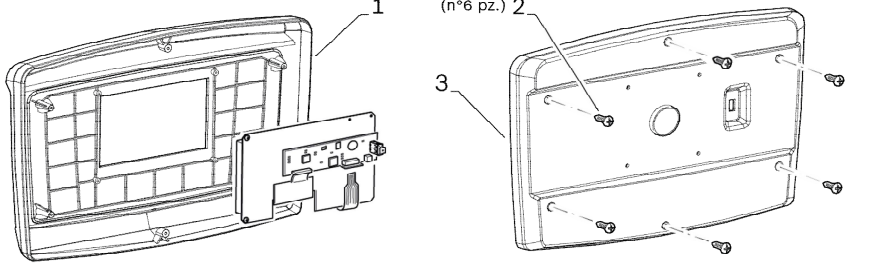
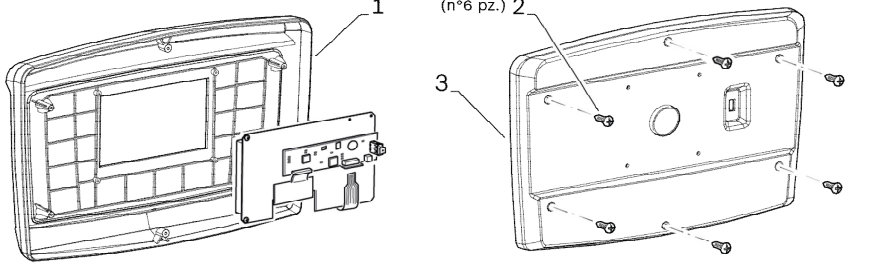
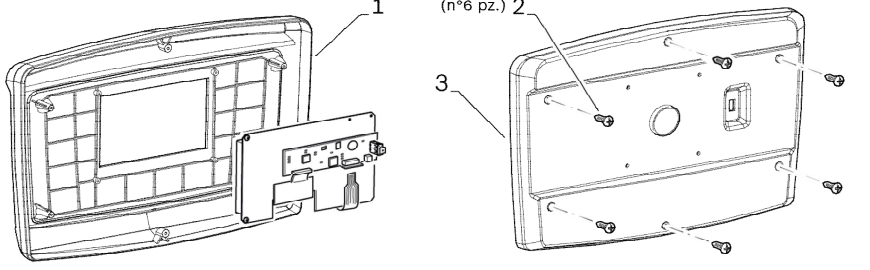
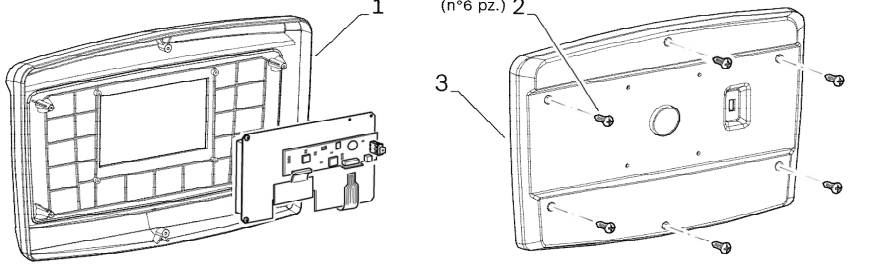
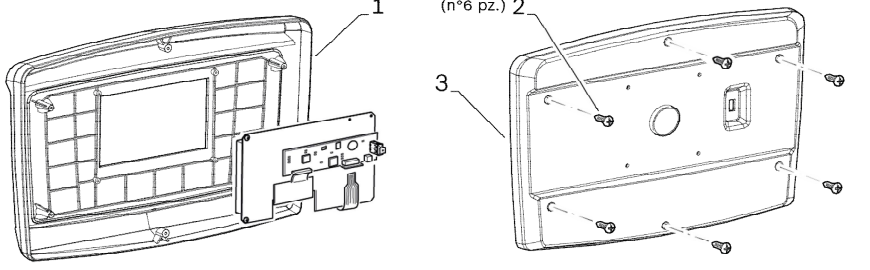
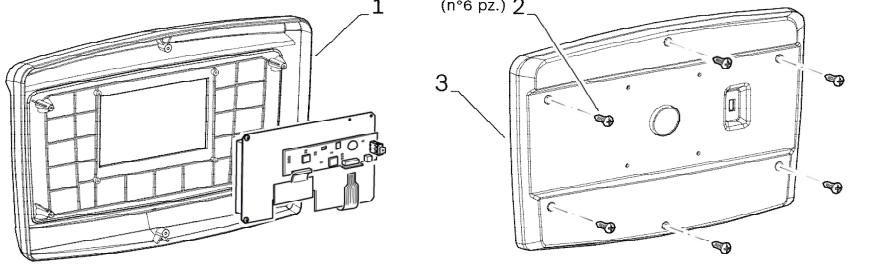
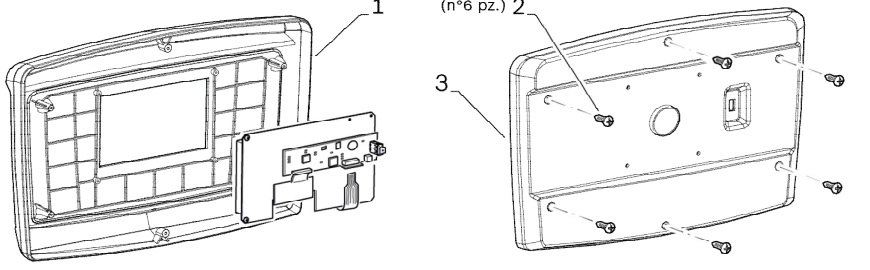
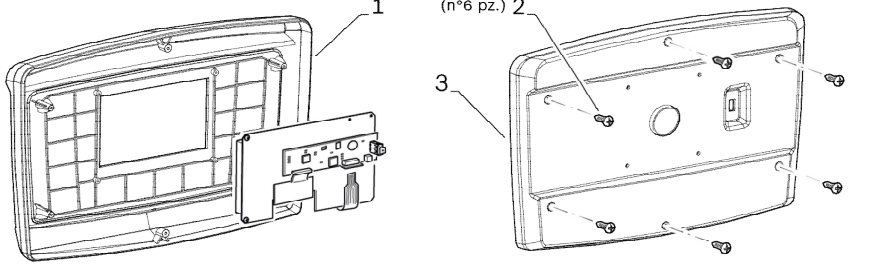
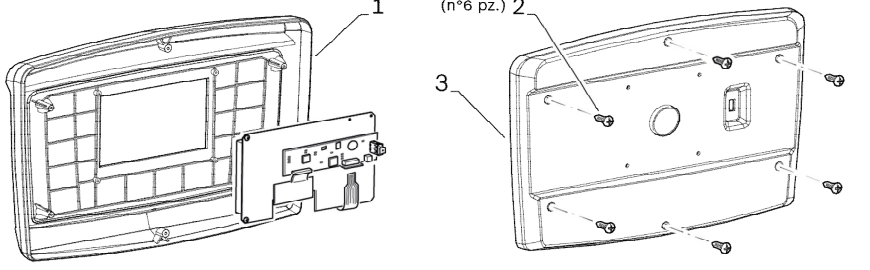
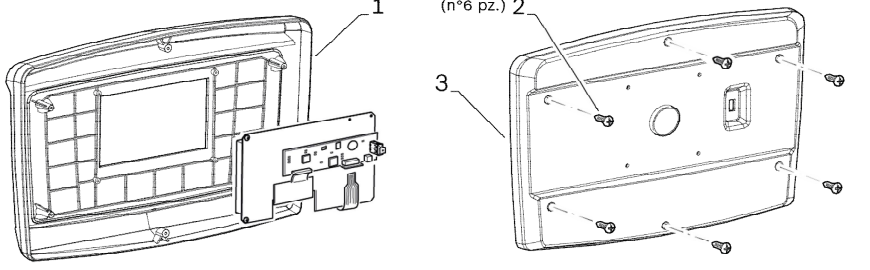
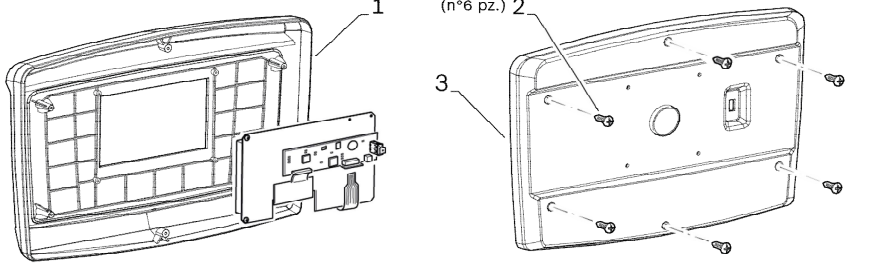
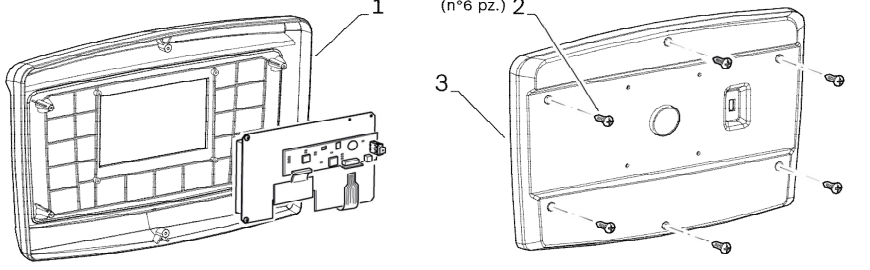
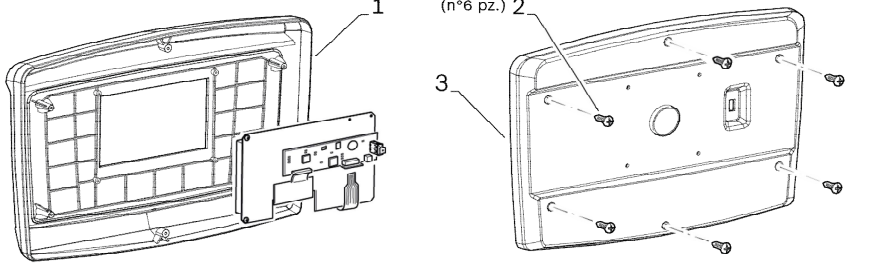
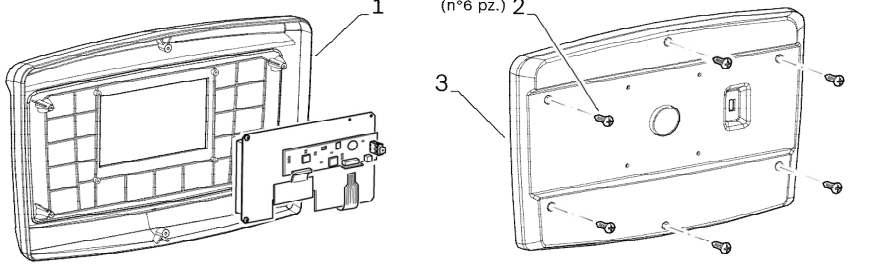
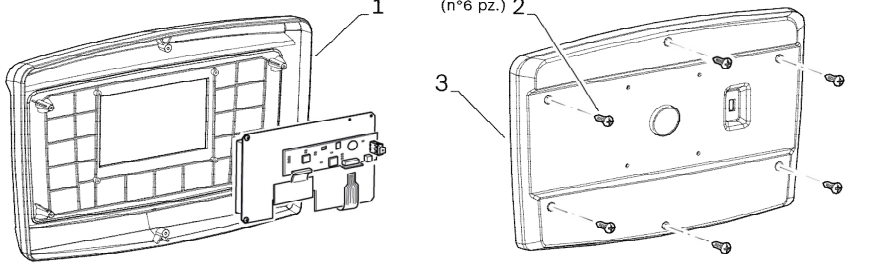
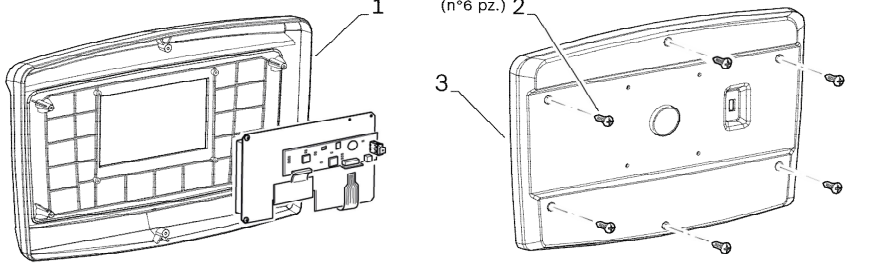
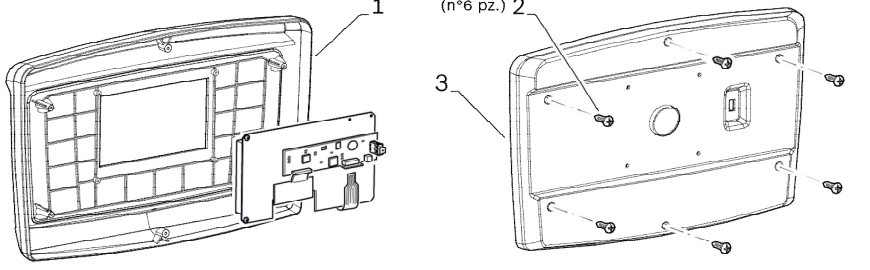
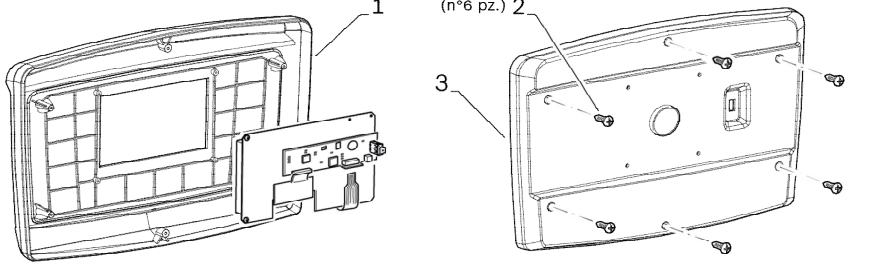
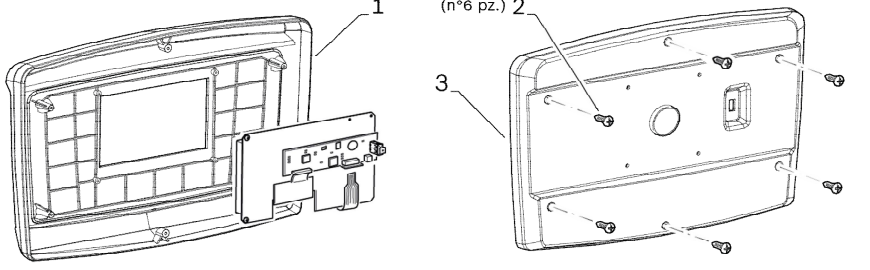
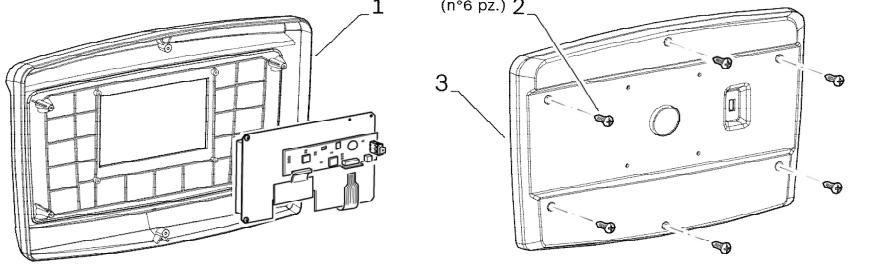
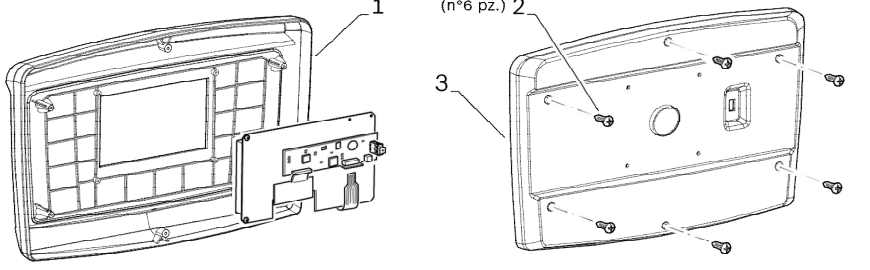
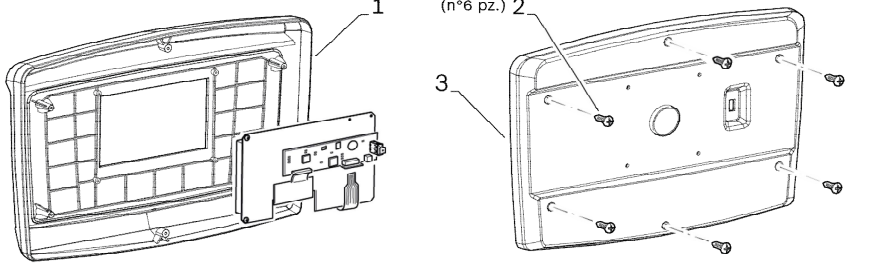

Pos.	Class	Intervall	Customer	Partnumber	IDENTIFICAZIONE (it)	BEZEICHNUNG (de)	Drawing
					IDENTIFICATION (en)	IDENTIFICACION (es)	
					Comment (en)		
1	●	-	-	1695600977	Kit Pezzi Di Ricambio	Ersatzteilsatz	
					Service kit	Juego De Repuestos	
2	○	-	X	Normpart	Vite Autofilettante	Gewindeformschraube	
					Thread-Forming Screw	Tornillo Autorroscante	
					EN ISO 3,9x13		
3	●	-	-	1695600857	Copertura di plastica	Kunststoffabdeckung	
					plastic covering	cubierta de plástico	
4	●	-	-	1695601017	Cavo Elettrico	Elektr Leitung	
					Cable	Cable	
5	●	-	-	1695600825	Supporto monitor	Monitorhalter	
					Monitor mount	Soporte de monitor	
6	●	-	-	Normpart	Vite cilindrica esagonal	Innensechskantschraube	
					Hex Socket Head Cap Screw	Tornillo cilindrca hex	
					ISO 4762 M8x25		
7	○	-	-	Normpart	Rondella	Scheibe	
					Washer	Arandela	
					ISO 7089 Ø8		
801	●	-	-	1695600981	Kit Pezzi Di Ricambio	Ersatzteilsatz	
					Service kit	Juego De Repuestos	
802	●	-	-	1695600855	Pannello Di Comando	Bedienungskasten	
					Control Box	Caja De Maniobras	
							
							
							
							
							
							
							
							
							
							
							
							
							
							
							
							
							
							
							
							
							
							
							
							
							
							
							
							
							
							
							
							
							
							
							
							
							
							
							
							
							
							
							
							
							
							
							
							
							
							
							
							
							
							
							
							
							
							
							
							
							
							
							
							
							
							
							
							
							
							
							
							
							
							
							
							
							
							
							
							
							
							
							
							
							
							
							
							
							
							
							



Pos.	Class	Intervall	Customer	Partnumber	IDENTIFICAZIONE (it)	BEZEICHNUNG (de)
					IDENTIFICATION (en)	IDENTIFICACION (es)
					Comment (en)	
1	●	-	-	1695600892	SOTTOGRUPPO Assembly	Baugruppe Grupo Constructivo
2	●	-	-	1695600882	Motore Motor	Motor Motor
3	●	-	-	1695655963	Puleggia Pulley	Riemenscheibe Polea
4	○	-	-	Normpart	Rondella piana Plain Washer ISO 7093 6,5X24X4	Unterlegscheibe Arandela plana
5	○	-	-	Normpart	Vite cilindrica esagonale Hex Socket Head Cap Screw ISO 4762 M6x35	Innensechskantschraube Tornillo cilindrica hex
6	●	-	-	1695042409	Cinghia Di Trasmissione Drive Belt	Antriebsriemen Correa Motriz
7	○	-	-	1695603700	Anello Ring	Ring Anillo
8	●	-	-	1695603600	Disco forato Perforated disk	Lochscheibe Disco Agujereado
9	●	-	-	1695600943	Barriera Fotoelettrica Photoelec. Light Barrier	Lichtschranke Barrera De Luz
10	●	-	-	1695600878	Telaio Di Supporto Bearing Frame	Lagerrahmen Bastidor De Cojinete

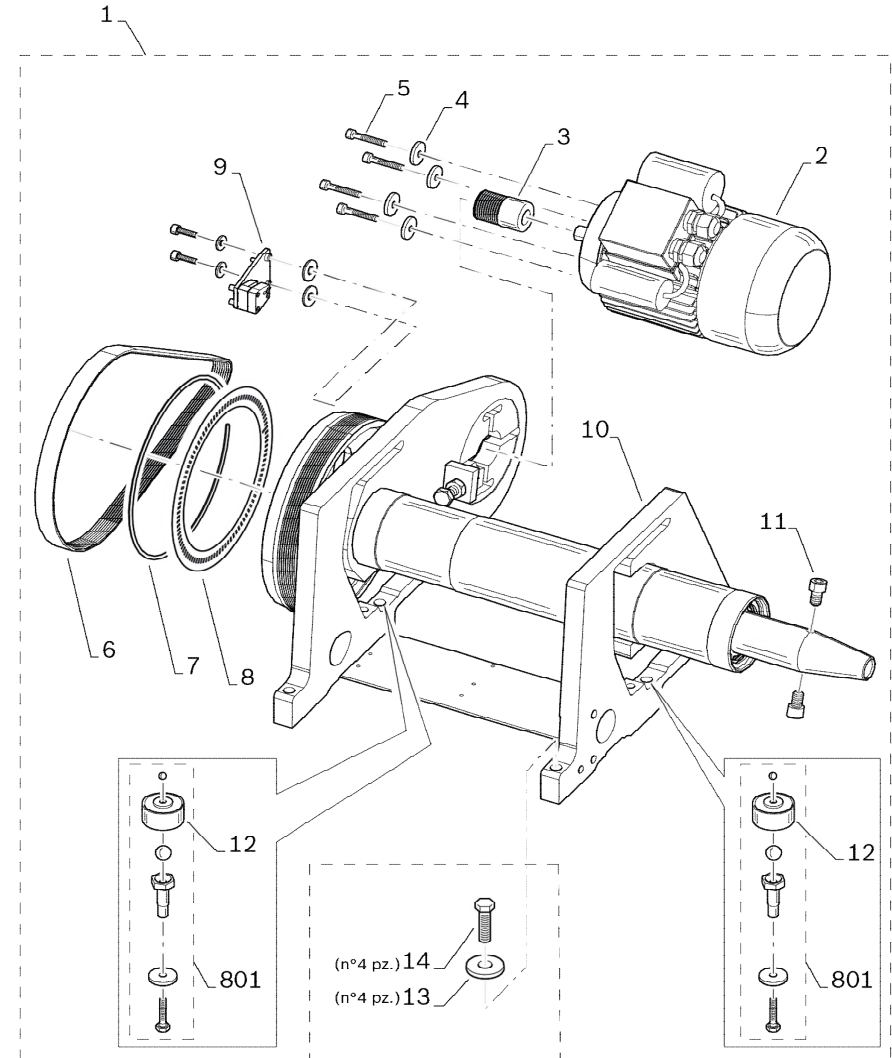



Pos.	Class	Intervall	Customer	Partnumber	IDENTIFICAZIONE (it)	BEZEICHNUNG (de)
					IDENTIFICATION (en)	IDENTIFICACION (es)
					Comment (en)	
1	●	-	-	Normpart	Vite cilindrica esagonal	Innensechskantschraube
					Hex Socket Head Cap Screw	Tornillo cilíndrica hex
					ISO 4762 M4x55	
2	●	-	-	Normpart	Anello a scatto elastico	Sprengring
					Retaining ring	Anillo elástico
					DIN 471 Ø13	
3	●	-	-	1695600778	Molla	Feder
					Spring	Resorte
4	●	-	-	1695600776	Perno	Kloben
					Block	Gozne
5	●	-	-	1695600777	Estrattore	Abziehvorrichtung
					Puller	Extractor
6	●	-	-	Normpart	Rondella piana	Unterlegscheibe
					Plain Washer	Arandela plana
					ISO 7089 Ø4	
7	●	-	-	Normpart	Vite Autofilettante	Gewindeformschraube
					Thread-Forming Screw	Tornillo Autorroscante
					ISO 7050 2,9x9,5	
8	●	-	-	1695600779	Pezzo Terminale	Abschlussstück
					Stopping Piece	Pieza De Remate
9	○	-	-	1695655756	Montaggio	Montage
					Assembly	Montaje

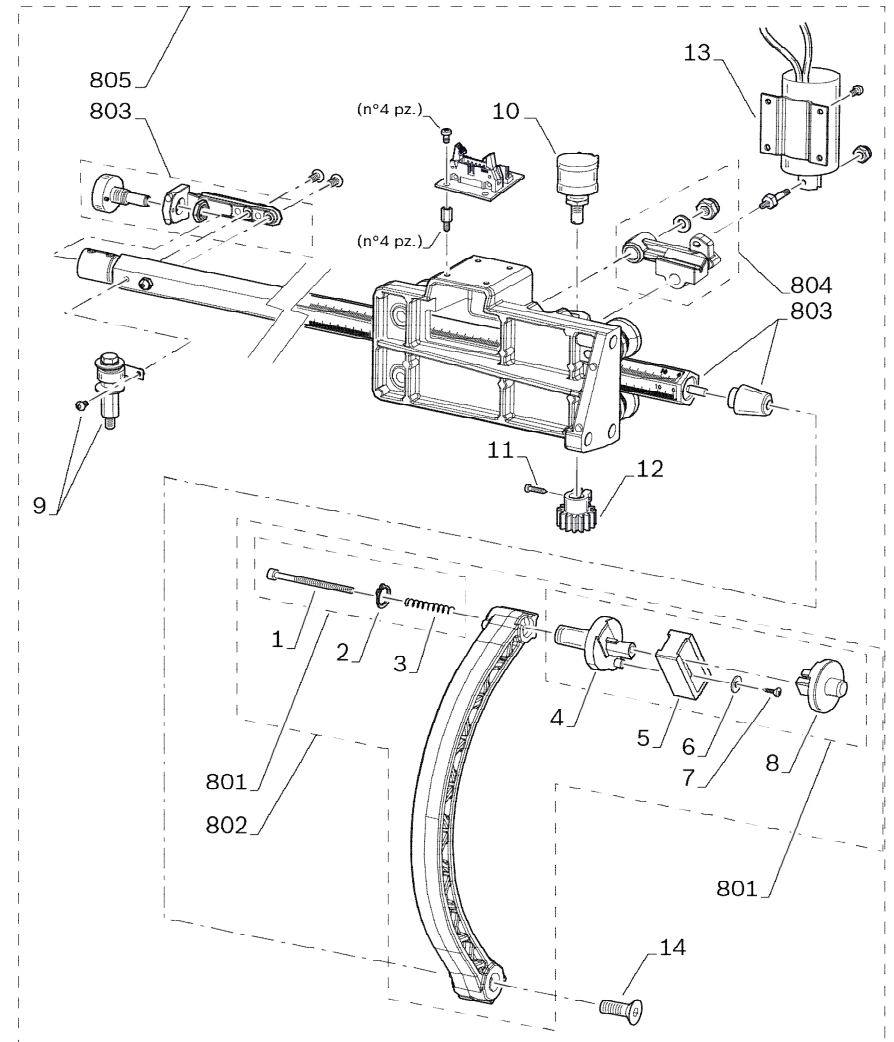

Pos.	Class	Intervall	Customer	Partnumber	IDENTIFICAZIONE (it)	BEZEICHNUNG (de)
					IDENTIFICATION (en)	IDENTIFICACION (es)
					Comment (en)	
10	●	-	-	1695600223	Potenziometro	Potentiometer
					Potentiometer	Potenciometro
11	●	-	-	Normpart	Vite Autofilettante	Gewindeformschraube
					Thread-Forming Screw	Tornillo Autorroscante
					ISO 7380 M4x8	
12	●	-	-	1695656042	Pignone	Ritzel
					Pinion	Pinon
13	●	-	-	1695600955	Elettromagnete	Elektromagnet
					Electromagnet	Electroiman
14	○	-	-	Normpart	Vite svasata esagonale	Innensechsktsenkschraube
					Hex socket countrsk screw	Tornillo Avellanada Hex
					EN ISO 10642 M6x16	
801	●	-	-	1695600983	Kit Pezzi Di Ricambio	Ersatzteilsatz
					Service kit	Juego De Repuestos
802	●	-	-	1695600775	Leva Di Posizione	Stellhebel
					Positioning Lever	Palanca De Ajuste
803	●	-	-	1695600982	Kit Pezzi Di Ricambio	Ersatzteilsatz
					Service kit	Juego De Repuestos
804	○	-	-	1695656655	Kit Pezzi Di Ricambio	Ersatzteilsatz
					Service kit	Juego De Repuestos
805	●	-	-	1695600772	Disp Di Misurazione	Benzinfördermessgerät
					Fuel Dlvy Meas.Device	Disp.Medicion Del Caudal

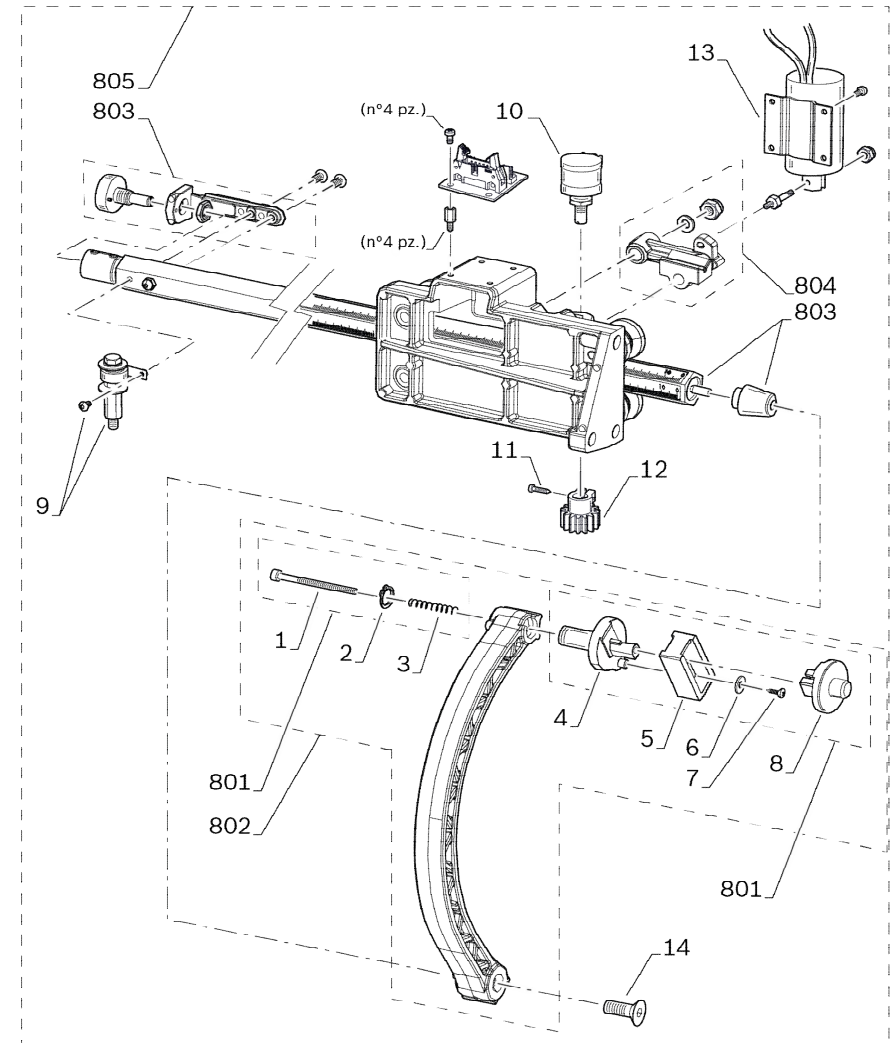

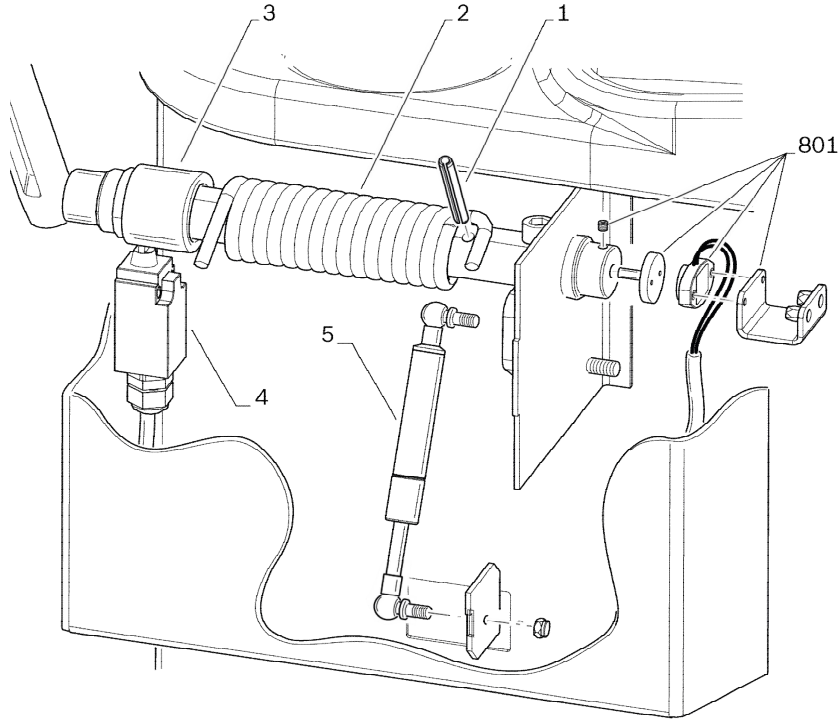
Pos.	Class	Intervall	Customer	Partnumber	IDENTIFICAZIONE (it)	BEZEICHNUNG (de)	Drawing
					IDENTIFICATION (en)	IDENTIFICACION (es)	
					Comment (en)		
1	①	-	-	Normpart	Spina Elastica	Flachkeil	
					Flat Key	Chaveta Plana	
					ISO 8758 Ø8x60		
2	①	-	-	1695600808	Molla	Feder	
					Spring	Resorte	
3	①	-	-	1695600400	Boccola	Buchse	
					Bushing	Casquillo	
4	①	-	-	1695600952	Microinterruttore	Mikroschalter	
					Microswitch	Microinterruptor	
5	①	-	-	1695600806	Smorzatore	Dämpfer	
					Damper	Amortiguador	
801	①	-	-	1695600984	Kit Pezzi Di Ricambio	Ersatzteilsatz	
					Service kit	Juego De Repuestos	

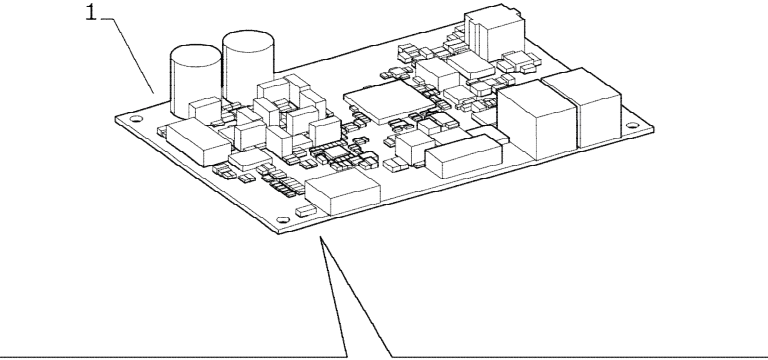
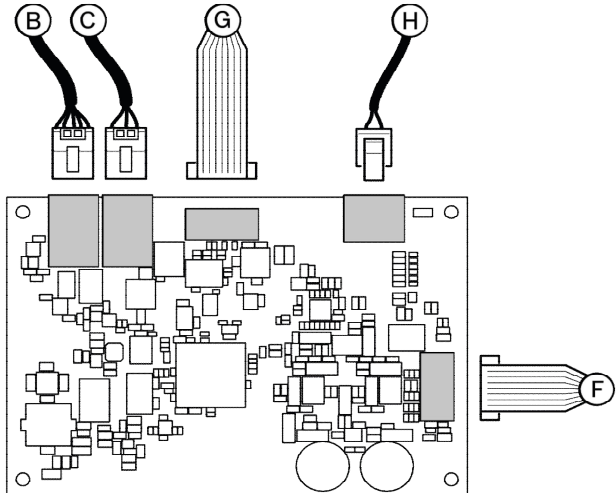

Pos.	Class	Intervall	Customer	Partnumber	IDENTIFICAZIONE (it)	BEZEICHNUNG (de)	Drawing
					IDENTIFICATION (en)	IDENTIFICACION (es)	
					Comment (en)		
1	●	-	-	1695600769	Scheda principale	Hauptplatine	
					Motherboard	Platina principal	
B	●	-	-	1695600947	Cavo Elettrico	Elektr Leitung	
					Cable	Cable	
C	●	-	-	1695600947	MCU connection cable		
					Cavo Elettrico	Elektr Leitung	
F	●	-	-	1695600944	Cable	Cable	
					LPU connection cable		
G	●	-	-	1695600943	Cavo Elettrico	Elektr Leitung	
					Calibers cable		
H	●	-	-	1695600955	Barriera Fotoelettrica	Lichtschranke	
					Photoelec. Light Barrier	Barrera De Luz	
					Elettromagnete	Elektromagnet	
					Electromagnet	Electroiman	
							

Pos.	Class	Intervall	Customer	Partnumber	IDENTIFICAZIONE (it)	BEZEICHNUNG (de)	Drawing
					IDENTIFICATION (en)	IDENTIFICACION (es)	
					Comment (en)		
1	●	-	-	1695600805	Scheda	Reglerkarte	
					Control Card	tarjeta de regulador	
2	●	-	-	1695600898	Scheda	Reglerkarte	
					Control Card	tarjeta de regulador	
F	⓪	-	-	1695600944	Cavo Elettrico	Elektr Leitung	
					Cable	Cable	
I	⓪	-	-	1695600939	Calibers cable		
					Sensore magnetico	Detektor	
L	⓪	-	-	1695600952	Sensor	Detector	
					Microinterruttore	Mikroschalter	
Q	⓪	-	-	1695600953	Microswitch	Microinterruptor	
					Cavo Elettrico	Elektr Leitung	
R	⓪	-	-	1695600957	Cable	Cable	
					MCU connection cable		
					Sensore Sonar	Messfühler	
					Sensor	Palpador de medición	

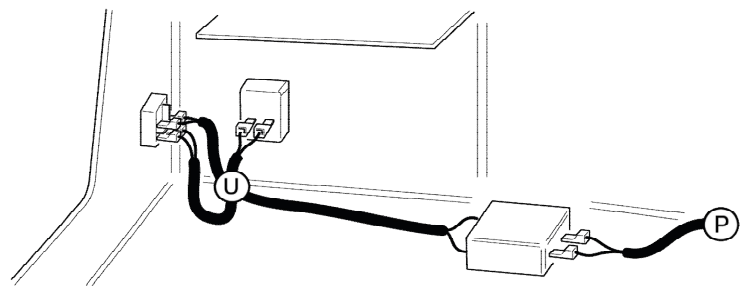
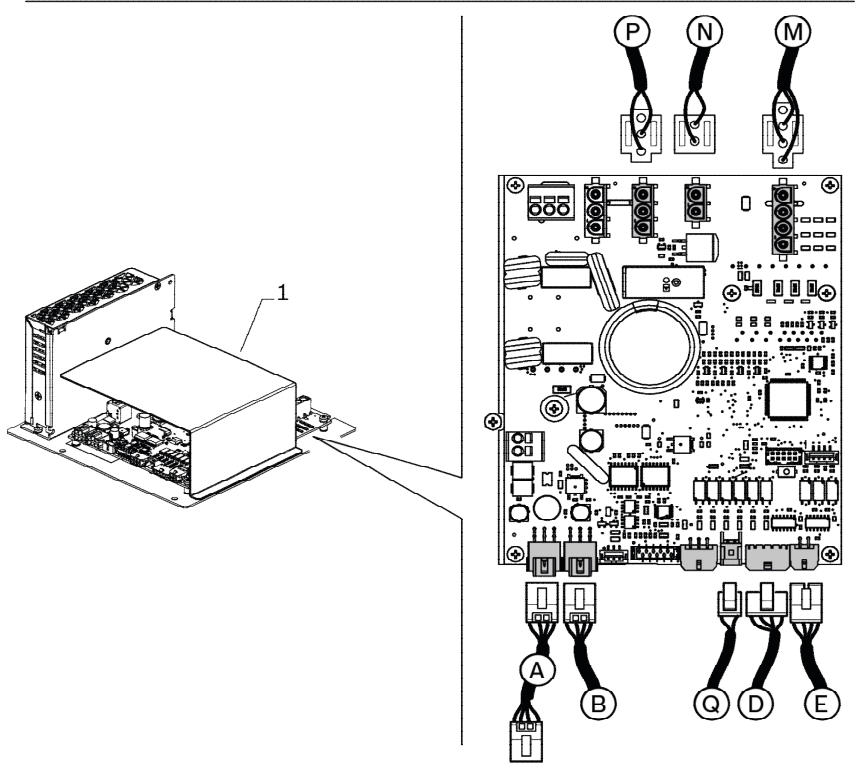
Pos.	Class	Intervall	Customer	Partnumber	IDENTIFICAZIONE (it)	BEZEICHNUNG (de)	Drawing	
					IDENTIFICATION (en)	IDENTIFICACION (es)		
					Comment (en)			
1	●	-	-	1695600813	Scheda	Baugruppe		
					Subassembly	Conjunto		
A	●	-	-	1695600948	Cavo Elettrico	Elektr Leitung		
					Cable	Cable		
Connection cable								
B	●	-	-	1695600947	Cavo Elettrico	Elektr Leitung		
					Cable	Cable		
WBU connection cable								
D	●	-	-	1695600896	Cavo Comando Freno	Bremsseil		
					Brake Cable	Cable Del Freno		
Input cable for brake pedal								
E	●	-	-	1695600956	Cavo Elettrico	Elektr Leitung		
					Cable	Cable		
Electrovalve cables								
M	●	-	-	1695600945	Cavo Elettrico	Elektr Leitung		
					Cable	Cable		
Motor cable								
N	●	-	-	1695600946	Cavo Elettrico	Elektr Leitung		
					Cable	Cable		
Brake power cable								
P	●	-	-	1695600950	Cavo Elettrico	Elektr Leitung		
					Cable	Cable		
Board power cable								
Q	●	-	-	1695600953	Cavo Elettrico	Elektr Leitung		
					Cable	Cable		
Board connection cable								
U	●	-	-	1695600951	Cavo Elettrico	Elektr Leitung		
					Cable	Cable		
Filter cable								

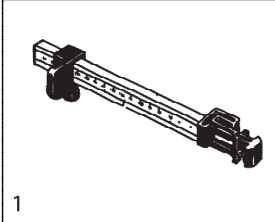
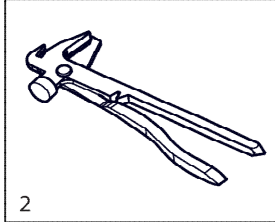
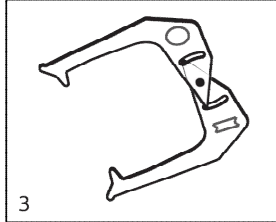
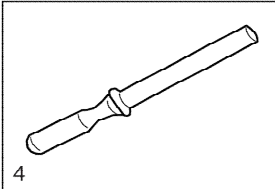
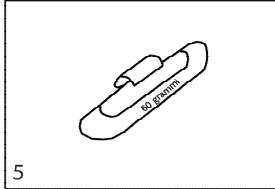
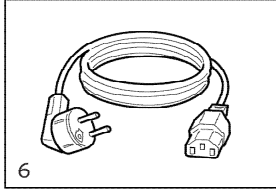
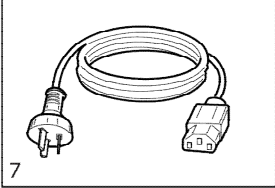
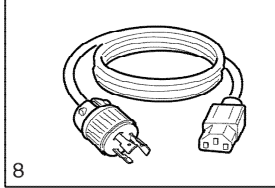
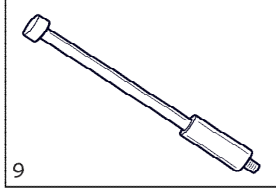
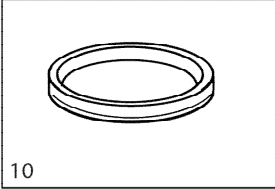
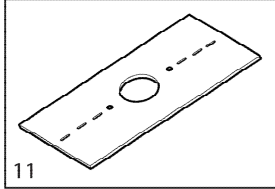
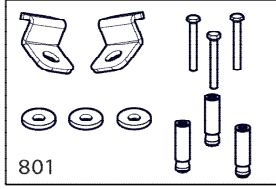
Pos.	Class	Intervall	Customer	Partnumber	IDENTIFICAZIONE (it)	BEZEICHNUNG (de)	Drawing
					IDENTIFICATION (en)	IDENTIFICACION (es)	
					Comment (en)		
1	●	-	X	1695629400	calibro	Lehre	
					Gauge	calibre	
2	●	-	X	1695606500	Pinza	Zange	
					Pair Of Tongs	Tenazas	
3	●	-	X	1695602700	Calibro	Messschieber	
					Caliper	Pie de rey	
4	●	-	X	1695656585	Circuito Stampato	Leiterplatte	
					Printed Circuit Board	Tarjeta Circ Impreso	
5	●	-	X	1695654377	Contrappeso	Ausgleichgewicht	
					Counterweight	Contrapeso	
6	⓪	-	X	1695652991	Cavo di potenza	Leistungskabel	
					Power Cable	cable p.energia electr.	
7	⓪	-	-	1695656946	Cavo di potenza	Leistungskabel	
					Power Cable	cable p.energia electr.	
8	⓪	-	-	1695042146	Cavo di potenza	Leistungskabel	
					Power Cable	cable p.energia electr.	
9	○	-	X	1695656719	Utensile di calibrazione	Abgleichlehre	
					Calibration tool	Utensilio de calibración	
10	●	-	X	1695624800	Anello Di Gomma	Gummiring	
					Rubber Ring	Anillo De Goma	
							
							



Pos.	Class	Intervall	Customer	Partnumber	IDENTIFICAZIONE (it)	BEZEICHNUNG (de)	Drawing
					IDENTIFICATION (en)	IDENTIFICACION (es)	
					Comment (en)		
1	①	-	X	1695653212	Manicotto	Manschette	
					Sleeve	Manguito	
					L.100 mm		
1*	①	-	-	1695600999	Manicotto	Manschette	
					Sleeve	Manguito	
					L.130 mm		
2	●	-	X	1695616100	Anello	Ring	
					Ring	Anillo	
3	●	-	X	1695616500	Manicotto	Manschette	
					Sleeve	Manguito	
4	●	-	X	1695624800	Anello Di Gomma	Gummiring	
					Rubber Ring	Anillo De Goma	
5	●	-	X	1695632500	Cono di centraggio	Zentrierkonus	
					Centering cone	Cono de centrado	
6	●	-	X	1695652862	Cono	Konus	
					Cone	Cono	
7	●	-	X	1695605600	Cono	Konus	
					Cone	Cono	
8	●	-	X	1695606300	Cono di centraggio	Zentrierkonus	
					Centering cone	Cono de centrado	
9	①	-	-	1695653255	Flangia	Flansch	
					Flange	Brida	

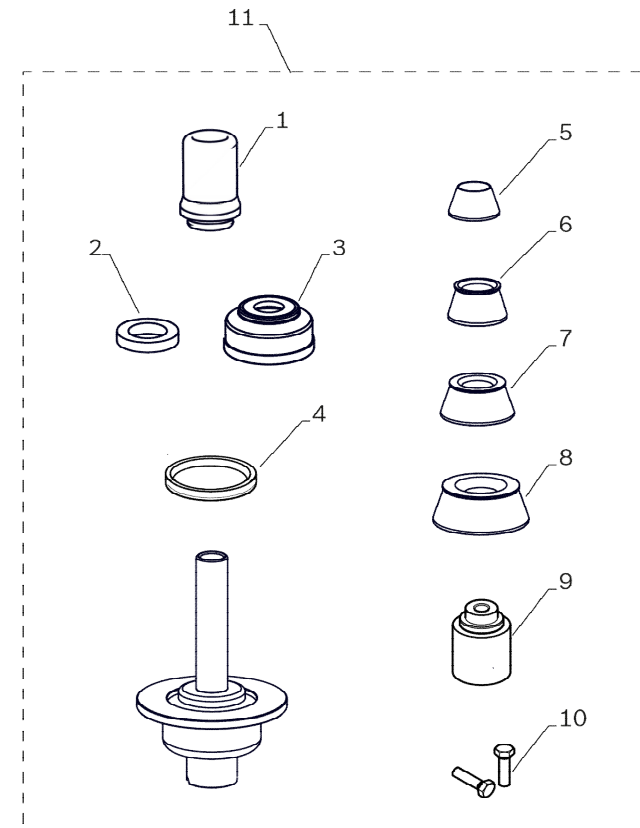



Date	Product	Editor	Modification
2019-01-23	SBM WAVE 5 LCD AWP	Bove	New product
2019-11-18	SBM WAVE 5 LCD AWP	Bove	New versions added; KDU boards not supplied; Complete control panel P/N added; KDU cable added; Customization in RAL 7040 added; Power cables USA and Australia added



Sicam S.r.l.  
Tyre Equipments & Tools  
Via G. Corradini, 1  
42015 Correggio (RE)  
ITALY  
[www.sicam.it](http://www.sicam.it)

1 695 656 866 - 2019-11-18